



Surgicals & Instruments

Quality is Reward of Hardwork

Since last 18 years



SPINAL SURGERY

INSTRUMENTS



CDSCO Reg No-Allian-Thris-KL/M/MD/009981

ANNANAD P.O, CHALAKUDY THRISSUR, KERALA - 680309
Email: info@alliancesurgicals.com Website: www.alliancesurgicals.com
Ph.+91 0480 2717722 Mob +919349855004



Alliance

Surgicals & Instruments

Quality is Reward of Hardwork

Introduction

Alliance Surgical is an established manufacture of surgical instruments. With our wide range we cover Instruments for surgeries from head to toe.

We present our catalogue detailing our range of instrument-ation for Orthopaedic Surgery.

These specialist Instruments are manufactured to the highest possible standards with the most modern processes and technology.



96629040000065@cnrb

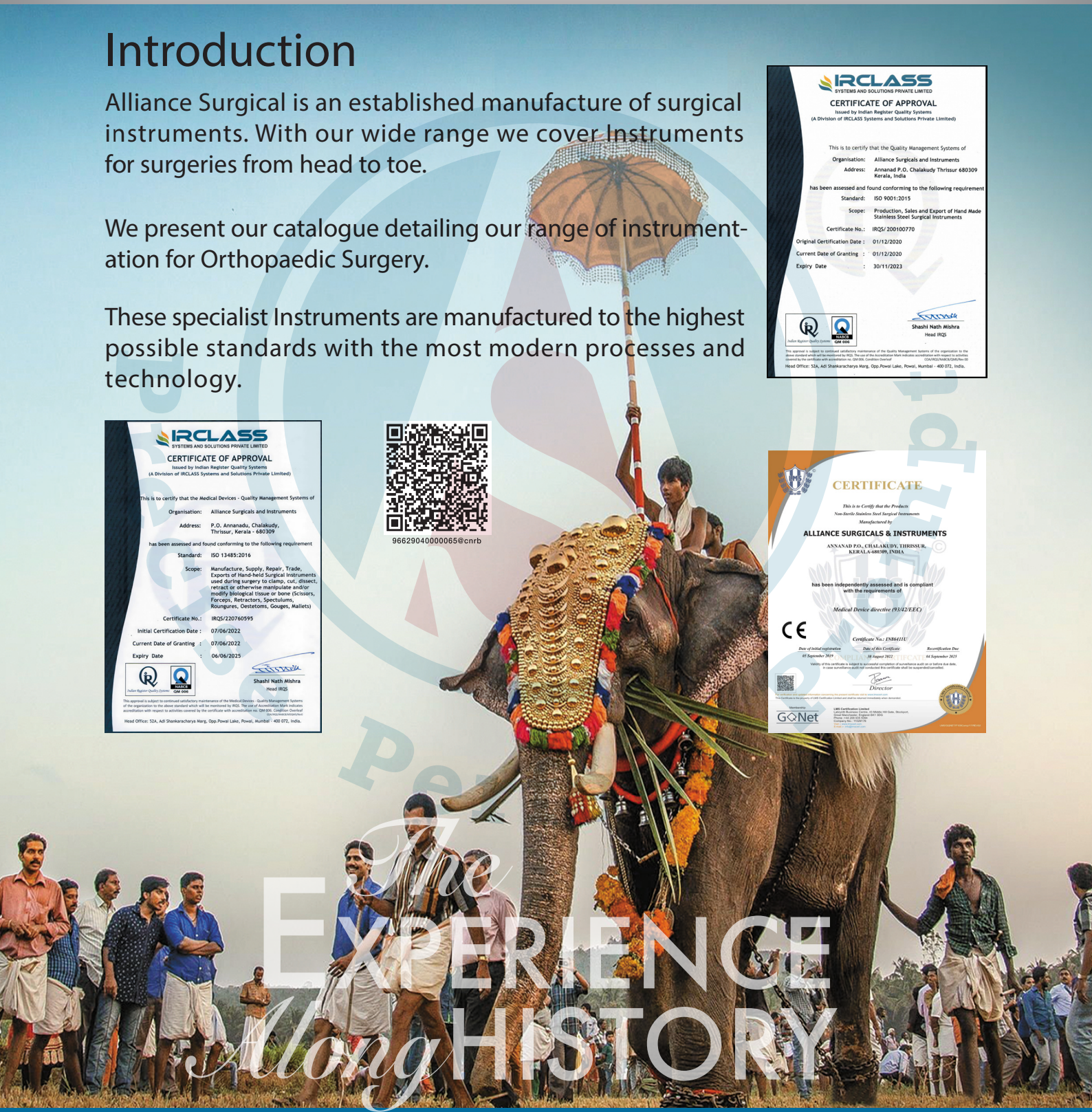

The EXPERIENCE Along HISTORY

ANNANAD P.O, CHALAKUDY, THRISSUR, KERALA - 680309
Email: info@alliancesurgicals.com, Website: www.alliancesurgicals.com



Surgicals & Instruments

Quality is Reward of Hardwork

INDEX.

LAMINECTOMY PUNCHES

	Page No		Page No.
90° Kerrison Laminectomy Punch	1	Stille-Liston Bone Cutters	19
'Black Line' Kerrison Punch	2	Liston-Key-Horsley Bone Cutters	19
Bone Ejector Kerrison Punch	2	Tudor Edwards/Vehmehren Costotome	19
Thin Footplate Kerrison Punch	3		
Wide Opening Kerrison Punch	3		
'Clean Wave' Laminectomy Punch	4		
Love Kerrison Punch	4		
Long Anterior Kerrison Punch	5		
Curved Foramenotomy Punch	5		
Ferris-Smith Kerrison Punch	6		
Osteo-Rotating Punch	6		

DISC RONGEURS

Intervertebral Disc Rongeur	7
Caspar Disc Rongeur	8
Schlesinger Toothed Rongeur	8
Williams Disc Rongeur	9
'Pea Pod' Disc Rongeur	9
Beck Disc Rongeur	9
Munich Grasping Forceps	10
Decker Rongeur	10
Nicola Biopsy Forceps	10
'Clean Wave' Intervertebral Rongeur	11
Ferris-Smith Rongeur	12
Anterior Disc Rongeur	12
Anterior Long Rongeur	12

BONE NIBBLERS & CUTTERS

Lempert Bone Nibbler	13
Luer Bone Nibbler	13
Adsons Bone Nibbler	13
Pennybacker Bone Nibbler	14
Northfields Bone Nibbler	14
'Rat Toothed' Bone Nibbler	14
Zielke Rongeur	15
Matzen Rongeur	15
Beyer Bone Nibbler	15
Jansen Bone Nibbler	16
Marquardt Bone Nibbler	16
Smith-Peterson Bone Nibbler	16
Stille-Luer Bone Nibbler	17
Leksell Bone Nibbler	17
Echlin Duckbill Nibbler	18
Long Anterior Leksell Bone Nibbler	18
Sypert Bone Nibbler	18
McIndoe Bone Cutters	19

OSTEOTOMES & MALLETS

Dahmen Osteotome	20
Lexer Osteotome	20
Stille Osteotome	20
Scaglietti Osteotome Set	21
Mallets	21 & 22

Page No.

ELEVATORS, GOUGES & IMPACTORS

Adson Elevator	23
Pennybacker Elevator	23
Bone Raspatory	23
Farabeuf Elevator	23
Trethowan Lever	24
Lanes Lever	24
Fagge Lever	24
Bristows Elevator	24
Hohmanns Lever	25
Inferior Hohmann Hip Retractor	25
Zielke Gouge	25
Capener Gouge	25
Cervical Impactor	26
Lumbar Impactor	26
Anterior Impactor	26
Cobb Elevators	27 & 28

SPINAL CURETTES

Bayonet Cervical Micro Curette Set	29
Karlin Style Bayonet Cervical Micro Curettes	30
Lempert Curette	31
Bruns Curette	31
Tufnol Handle Curette	31
Double Handled Curette	32
Comfort Handle Curette	32
Long Anterior Curette	32
Light-Grip Cervical Curette	33
Light-Grip Lumbar Curette	34
Cones Curette	35
Zielke Curette	35
Volkman Curette	35



Surgicals & Instruments

Quality is Reward of Hardwork

	Page No		Page No
DISSECTORS			
Swedish Dissector	36	Wests/Weitlaner S/R Retractor	47
Howarth Elevator	36	Travers S/R Retractor	47
MacDonald Elevator/Dissector	36	Norfolk & Norwich S/R Retractor	47
Watson Cheyne Dissector	36	Cones S/R Retractor	48
Freers Elevator/Dissector	36	Beckman-Adson S/R Retractor	48
CASPAR CERVICAL DISTRACTION SET			
Caspar Distraction Set	37 & 38	Gelpi Laminectomy S/R Retractor	49
LAMINA SPREADERS			
Cervical Vertebral Spreader	39	Hardman S/R Retractor	49
Cloward Cervical Spreader	39	Meyerding S/R Retractor	49
Cloward Lamina Spreader	39	Long Gelpi Orthopaedic S/R Retractor	50
Baby Inge Lamina Spreader	40	Viper Scoliosis S/R Retractor	50
Inge Lamina Spreader	40	Micro Discectomy Retractor System	51 & 52
Scaglietti Lamina Spreader	40	Micro Discectomy Instrument Set	53 & 54
Long Anterior Lamina Spreader	40	Black Belt Cervical Retractor System	55 & 56
HOOKS & PROBES			
Adson Dural Hook	41	Super-Slide Laminectomy Retractor System	57 & 58
Titanium Micro Hook	41	Caspar Retractor System	59 & 60
Crile Hook	41	Black Belt Micro Discectomy Retractor Set	61
Emmet Hook	41	BAYONET MICRO INSTRUMENTS FOR DURAL REPAIRS	
Cushing Hook	41	Yasargil Bayonet Micro Needle Holder	62
Adson Hook	42	Bayonet Micro Needle Holder	62
McCulloch Style Probe	42	Yasargil Bayonet Micro Forceps	62
Manipulation Hook	42	Yasargil Bayonet Micro Scissors	62
Blalock Blunt Hook	42	BIPOLAR FORCEPS	
Caspar Exploration Probe	42	Straight Bipolar Forceps	63
RETRACTORS			
Love Bayonet Nerve Root Retractor	43	Bayonet Bipolar Forceps	63 & 64
Krayenbuhl Nerve Root Retractor	43	MISC INSTRUMENTS	
O'Connell Nerve Root Retractor	43	Slim Nose Wire Twisters	65
Love Nerve Root Retractor	43	Orthopaedic Locking Pliers	65
Shepperd Suction Nerve Root Retractor	44	Combined Wire Cutters & Pliers	65
Nerve Root Retractor with Suction	44	Bolt Cutters	66
Hess Nerve Root Retractor	44	Muller-Claus Wire Cutters	66
Meyerding Retractor	45	Needle Nosed Locking Pliers	66
Langenbeck Retractor	45	Measuring Caliper/Gauges	67
Taylor Retractor	45	Suction Tubes	68
Cloward Blade Retractor	45	Bayonet Forceps	68
Bone Hook	45	Finocchio Spine Retractor	69
Volkman Retractor	45	Dr Remani Micro Dissectomy Retractor	69
Baby Weitlaner S/R Retractor	46	Mayfield Skull Retractor System	70
Mollison S/R Child Retractor	46	Wilson Radiolusent Frame	71
Mollison S/R Adult Retractor	46	MIS Tublar Retractor System	71
		Leyla Self Retaining Retractor System	72

Surgicals & Instruments

LAMINECTOMY PUNCH

Kerrison Laminectomy Punch

90° UPWARD Jaw angle

90° UPWARD JAW		
18 cm/7" Shaft	20 cm/8" Shaft	Bite Size
PS-AS 9071	FS-AS 9081	1 mm
PS-AS 9072	FS-AS 9082	2 mm
PS-AS 9073	FS-AS 9083	3 mm
PS-AS 9074	FS-AS 9084	4 mm
PS-AS 9075	FS-AS 9085	5 mm
PS-AS 9076	FS-AS 9086	6 mm

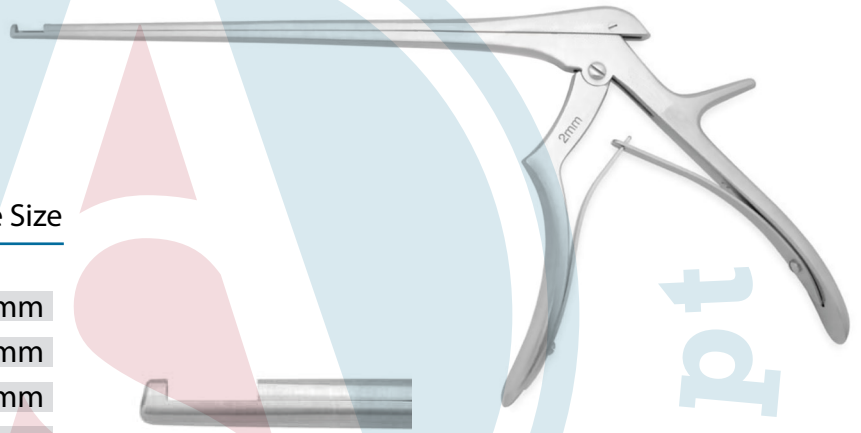

90°
UPWARD

Kerrison Laminectomy Punch

90° DOWNSIDE Jaw angle

90° DOWNSIDE JAW

18 cm/7" Shaft	20 cm/8" Shaft	Bite Size
PS-AS 9071	PS-AS 9081	1 mm
PS-AS 9072	PS-AS 9082	2 mm
PS-AS 9073	PS-AS 9083	3 mm
PS-AS 9074	PS-AS 9084	4 mm
PS-AS 9075	PS-AS 9085	5 mm
PS-AS 9076	PS-AS 9086	6 mm



90°
DOWNSIDE

Surgicals & Instruments

LAMINECTOMY PUNCH

"Black Line" Kerrison Laminectomy Punch

- 40° UPWARD Jaw angle
- With special Titanium coating on surface
- Bone ejector

40° UPWARD JAW

18 cm/7" Shaft 20 cm/8" Shaft 23 cm/9" Shaft Bite Size

PS-AS 4071 Ti	PS-AS 4081 Ti	PS-AS 4091 Ti	1 mm
PS-AS 4072 ETi	PS-AS 4082 ETi	PS-AS 4092 ETi	2 mm
PS-AS 4073 ETi	PS-AS 4083 ETi	PS-AS 4093 ETi	3 mm
PS-AS 4074 ETi	PS-AS 4084 ETi	PS-AS 4094 ETi	4 mm
PS-AS 4075 ETi	PS-AS 4085 ETi	PS-AS 4095 ETi	5 mm
PS-AS 4076 ETi	PS-AS 4086 ETi	PS-AS 4096 ETi	6 mm

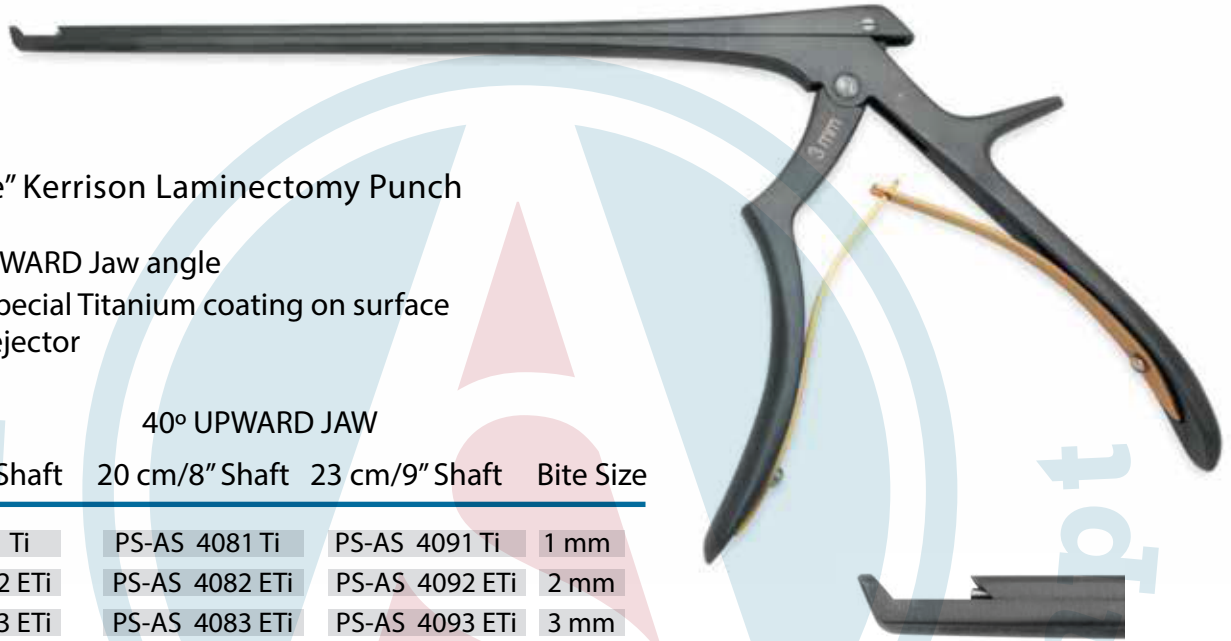

40°
UPWARD



Kerrison Laminectomy Punch with Bone Ejector

- 40° UPWARD Jaw angle
 - Bone ejector
- 40° UPWARD JAW

40°
UPWARD

18 cm/7" Shaft 20 cm/8" Shaft 23 cm/9" Shaft Bite Size

PS-AS 4071	PS-AS 4081	PS-AS 4091	1 mm
PS-AS 4072 E	PS-AS 4082 E	PS-AS 4092 E	2 mm
PS-AS 4073 E	PS-AS 4083 E	PS-AS 4093 E	3 mm
PS-AS 4074 E	PS-AS 4084 E	PS-AS 4094 E	4 mm
PS-AS 4075 E	PS-AS 4085 E	PS-AS 4095 E	5 mm
PS-AS 4076 E	PS-AS 4086 E	PS-AS 4096 E	6 mm

Surgicals & Instruments

LAMINECTOMY PUNCH

Thin Footplate Kerrison Laminectomy Punch

- 40° UPWARD Jaw angle
- Thin footplate for Cervical surgery

40° UPWARD JAW

18 cm/7" Shaft	20 cm/8" Shaft	Bite Size
PS-AS 4072 T	FS-AS 4082 T	2 mm
PS-AS 4073 T	FS-AS 4082 T	3 mm
PS-AS 4074 T	FS-AS 4084 T	4 mm
PS-AS 4075 T	FS-AS 4085 T	5 mm
PS-AS 4076 T	FS-AS 4086 T	6 mm

- Reduced footplate



40° UPWARD

- A reduced footplate thickness useful for a restricted operating area

Wide Opening Kerrison Laminectomy Punch

- 40° UPWARD Jaw angle
- 16mm Wide opening jaw

- 40° UPWARD Jaw angle
- 16mm Wide opening jaw

40° UPWARD JAW

20 cm/8" Shaft	Bite Size
PS-AS 4082	2 mm
PS-AS 4083	3 mm
PS-AS 4084	4 mm
PS-AS 4085	5 mm
PS-AS 4086	6 mm

- Wide opening jaws allowing the surgeon to envelope more bone

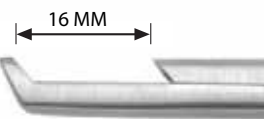

40° UPWARD

Surgicals & Instruments

LAMINECTOMY PUNCH

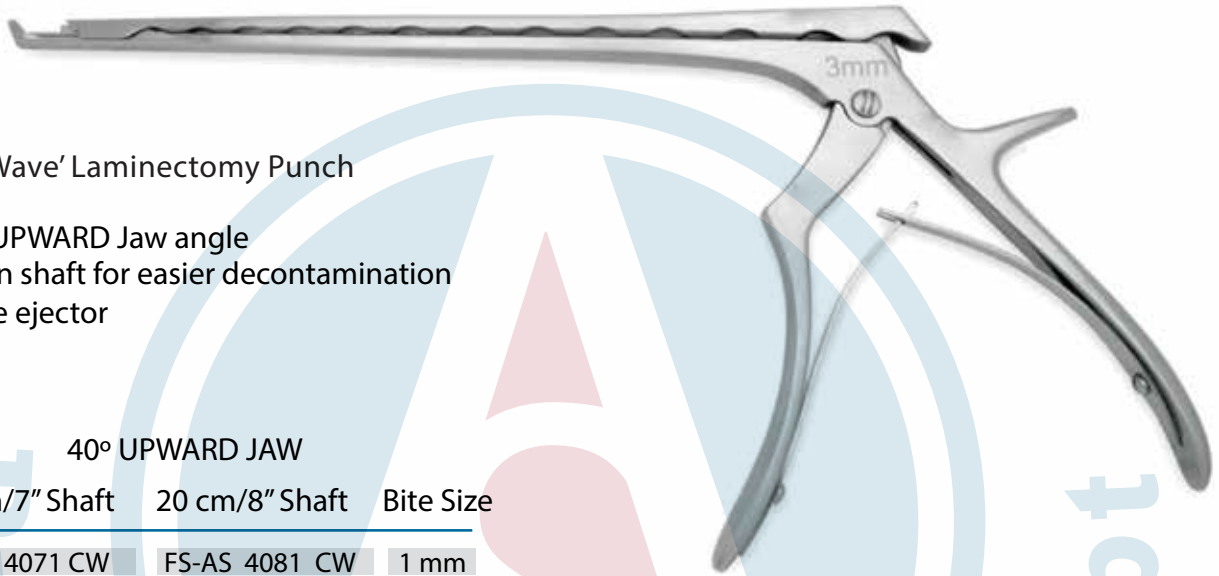

'Clean Wave' Laminectomy Punch

- 40° UPWARD Jaw angle
- Open shaft for easier decontamination
- Bone ejector

40° UPWARD JAW

18 cm/7" Shaft 20 cm/8" Shaft Bite Size

PS-AS 4071 CW	FS-AS 4081 CW	1 mm
PS-AS 4072 ECW	FS-AS 4082 ECW	2 mm
PS-AS 4073 ECW	FS-AS 4083 ECW	3 mm
PS-AS 4074 ECW	FS-AS 4084 ECW	4 mm
PS-AS 4075 ECW	FS-AS 4085 ECW	5 mm
PS-AS 4076 ECW	FS-AS 4086 ECW	6 mm

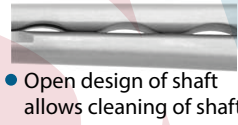

- Open design of shaft allows cleaning of shaft

- Bone ejector



40° UPWARD

Love Kerrison Punch

- 40° UPWARD Jaw angle
- Oversize handle



40° UPWARD JAW

20 cm/8" Shaft Bite Size

PS-AS 4082	2 mm
PS-AS 4083	3 mm
PS-AS 4084	4 mm
PS-AS 4085	5 mm



40° UPWARD

Surgicals & Instruments

LAMINECTOMY PUNCH

Long Anterior Kerrison Laminectomy Punch

- 40° UPWARD Jaw angle
- With special Titanium coating on surface
- Extra long shaft for Thoracic approach
- Bone ejector

40° UPWARD JAW

28 cm/11" Shaft	Bite Size
PS-AS 4002 ETi	2 mm
PS-AS 4003 ETi	3 mm
PS-AS 4004 ETi	4 mm
PS-AS 4005 ETi	5 mm
PS-AS 4006 ETi	6 mm

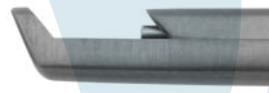
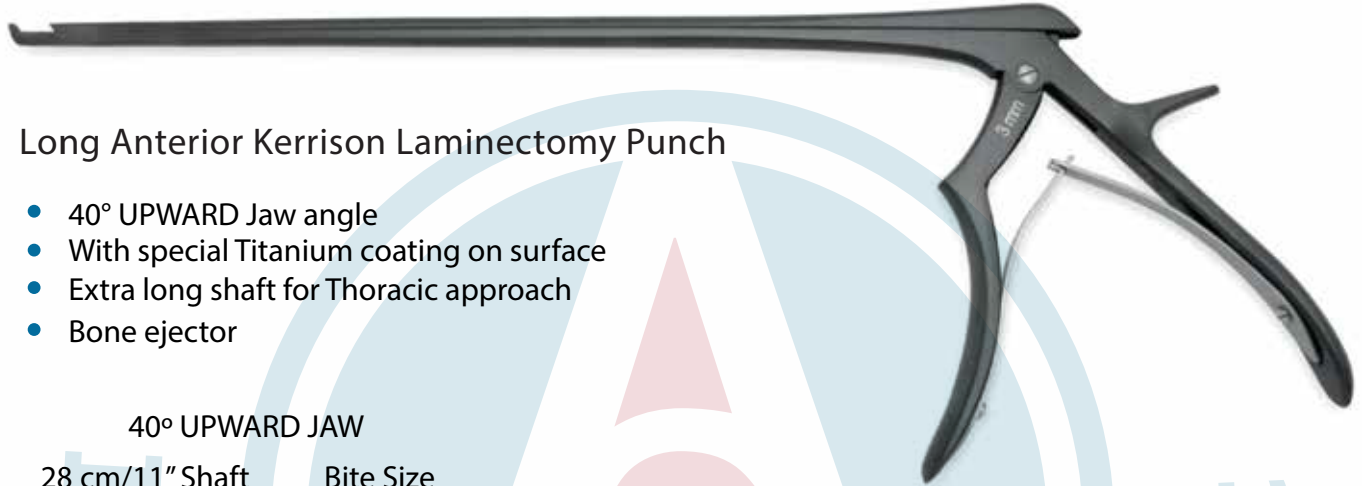

40° UPWARD

Curved Foramenotomy Punch

- 40° UPWARD Jaw angle
- Curved shaft designed to improve access to the Foramen

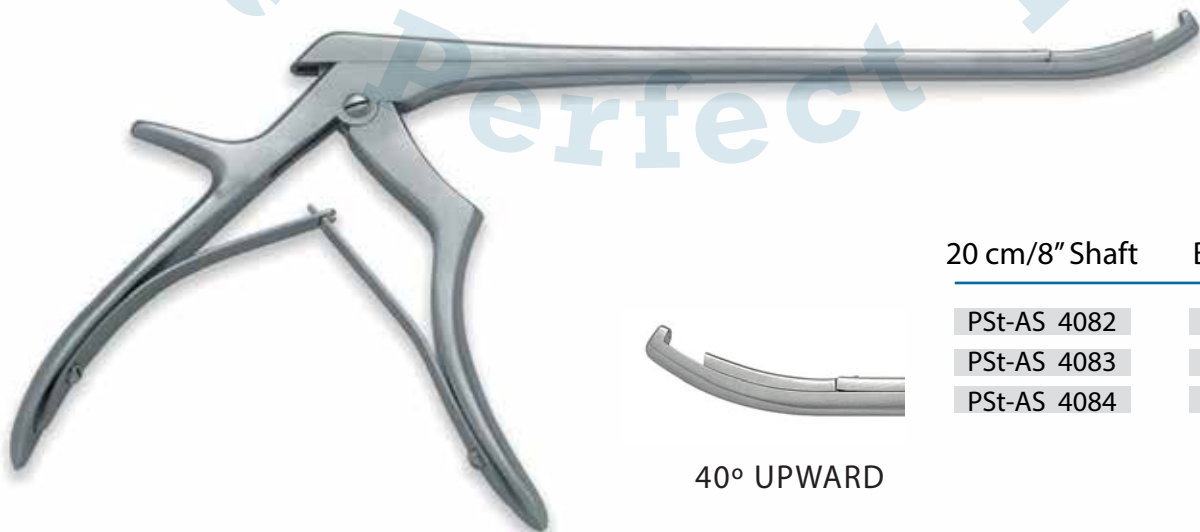

20 cm/8" Shaft Bite Size

PSt-AS 4082	2 mm
PSt-AS 4083	3 mm
PSt-AS 4084	4 mm

40° UPWARD

Surgicals & Instruments

LAMINECTOMY PUNCH

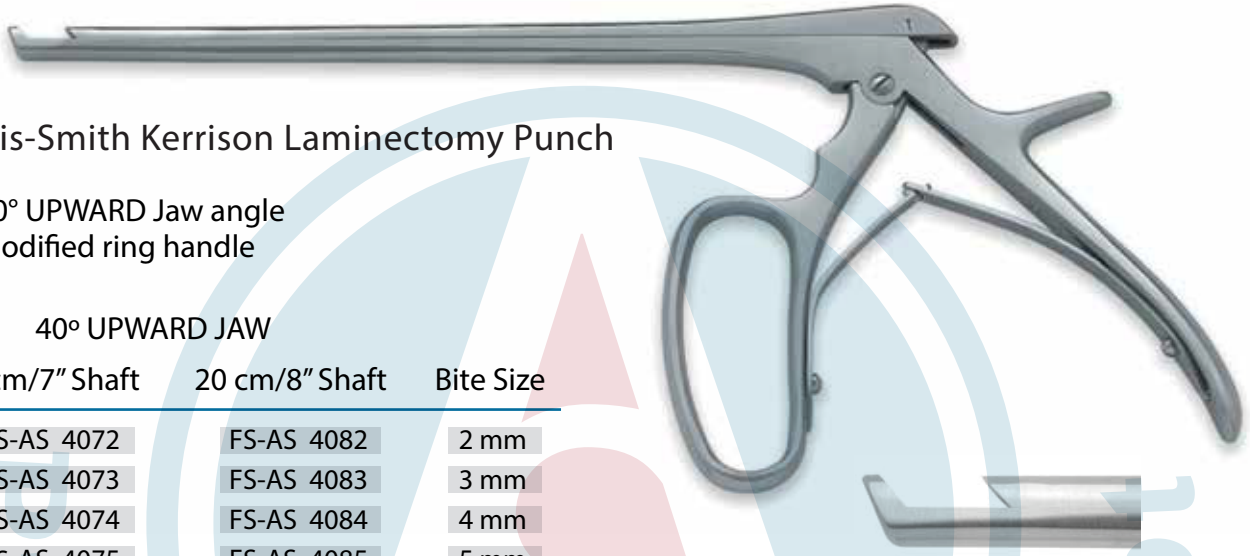

Ferris-Smith Kerrison Laminectomy Punch

- 40° UPWARD Jaw angle
- Modified ring handle

40° UPWARD JAW

18 cm/7" Shaft	20 cm/8" Shaft	Bite Size
PS-AS 4072	FS-AS 4082	2 mm
PS-AS 4073	FS-AS 4083	3 mm
PS-AS 4074	FS-AS 4084	4 mm
PS-AS 4075	FS-AS 4085	5 mm
PS-AS 4076	FS-AS 4086	6 mm

40° UPWARD

Osteo-Rotating Punch

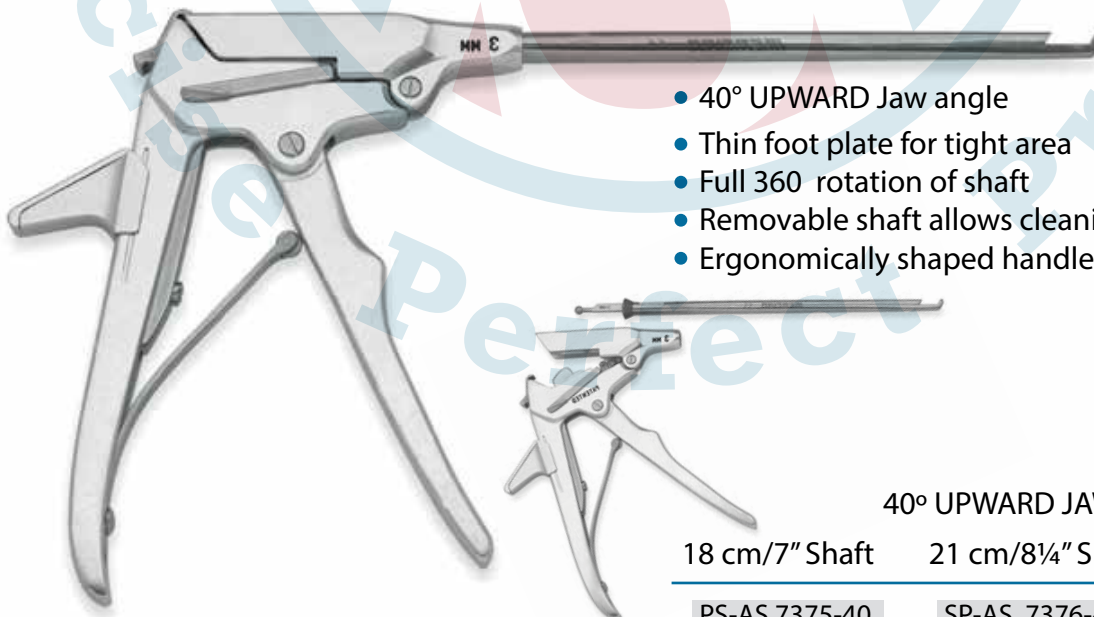

- 40° UPWARD Jaw angle
- Thin foot plate for tight area
- Full 360° rotation of shaft
- Removable shaft allows cleaning & replacement
- Ergonomically shaped handle

40° UPWARD JAW

18 cm/7" Shaft	21 cm/8¼" Shaft	Bite Size
PS-AS 7375-40	SP-AS 7376-40	0.6 mm
PS-AS 7375-41	SP-AS 4083-41	1 mm
PS-AS 7375-42	SP-AS 4084-42	2 mm
PS-AS 7375-43	SP-AS 4085-43	3 mm
PS-AS 7375-44	SP-AS 4086-44	4 mm

Surgicals & Instruments

Intervertebral Disc Rongeur

DISC RONGEURS

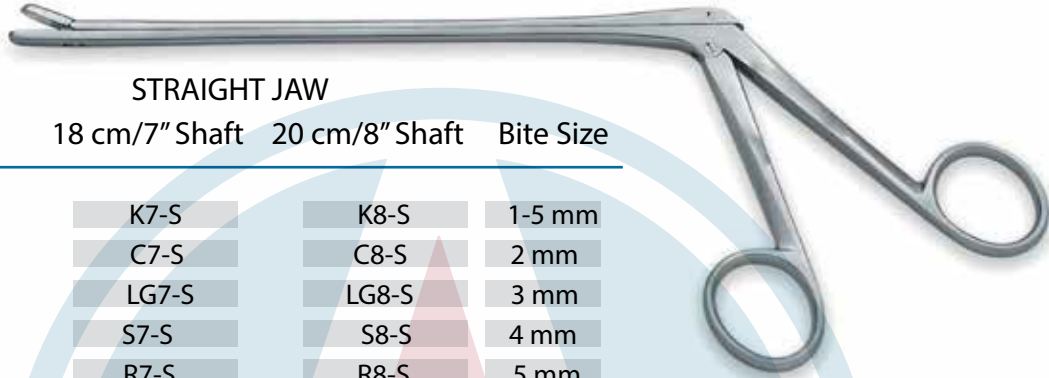

STRAIGHT JAW

15 cm/6" Shaft	18 cm/7" Shaft	20 cm/8" Shaft	Bite Size
K6-S	K7-S	K8-S	1-5 mm
C6-S	C7-S	C8-S	2 mm
LG6-S	LG7-S	LG8-S	3 mm
S6-S	S7-S	S8-S	4 mm
R6-S	R7-S	R8-S	5 mm
P6-S	P7-S	P8-S	6 mm
Q6-S	Q7-S	Q8-S	7 mm

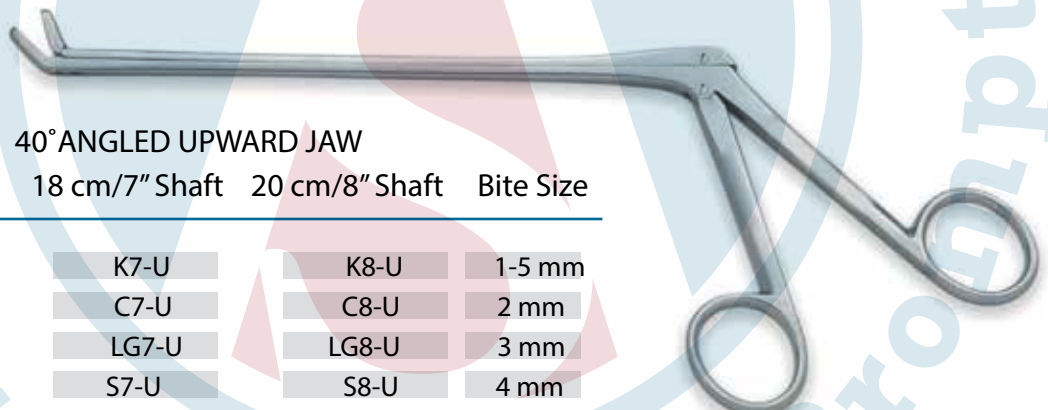

40° ANGLED UPWARD JAW

15 cm/6" Shaft	18 cm/7" Shaft	20 cm/8" Shaft	Bite Size
K6-U	K7-U	K8-U	1-5 mm
C6-U	C7-U	C8-U	2 mm
LG6-U	LG7-U	LG8-U	3 mm
S6-U	S7-U	S8-U	4 mm
R6-U	R7-U	R8-U	5 mm
P6-U	P7-U	P8-U	6 mm
Q6-U	Q7-U	Q8-U	7 mm



40° ANGLED DOWNWARD JAW

15 cm/6" Shaft	18 cm/7" Shaft	20 cm/8" Shaft	Bite Size
K6-D	K7-D	K8-D	1-5 mm
C6-D	C7-D	C8-D	2 mm
LG6-D	LG7-D	VLG8-D	3 mm
S6-D	S7-D	S8-D	4 mm
R6-D	R7-D	R8-D	5 mm
P6-D	P7-D	P8-D	6 mm
Q6-D	Q7-D	Q8-D	7 mm

Surgicals & Instruments

Caspar Toothed Disc Rongeur

DISC RONGEURS

- Serrated and fenestrated jaws

STRAIGHT JAW

16 cm/6¼" Shaft	18 cm/7" Shaft	Bite Size
PS-AS1502 -16	PS-AS1502 -18	2 mm
PS-AS1503 -16	PS-AS1503 -18	3 mm
PS-AS1504 -16	PS-AS1504 -18	4 mm
PS-AS1505 -16	PS-AS1505 -18	5 mm

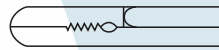

UPWARD JAW

16 cm/6¼" Shaft	18 cm/7" Shaft	Bite Size
PS-AS1602 -16	PS-AS1602 -18	2 mm
PS-AS1603 -16	PS-AS1603 -18	3 mm
PS-AS1604 -16	PS-AS1604 -18	4 mm
PS-AS1605 -16	PS-AS1605 -18	5 mm

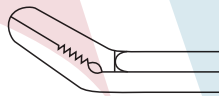

DOWNWARD JAW

16 cm/6¼" Shaft	18 cm/7" Shaft	Bite Size
PS-AS1702 -16	PS-AS1702 -18	2 mm
PS-AS1703 -16	PS-AS1703 -18	3 mm
PS-AS1704 -16	PS-AS1704 -18	4 mm
PS-AS1705 -16	PS-AS1705 -18	5 mm

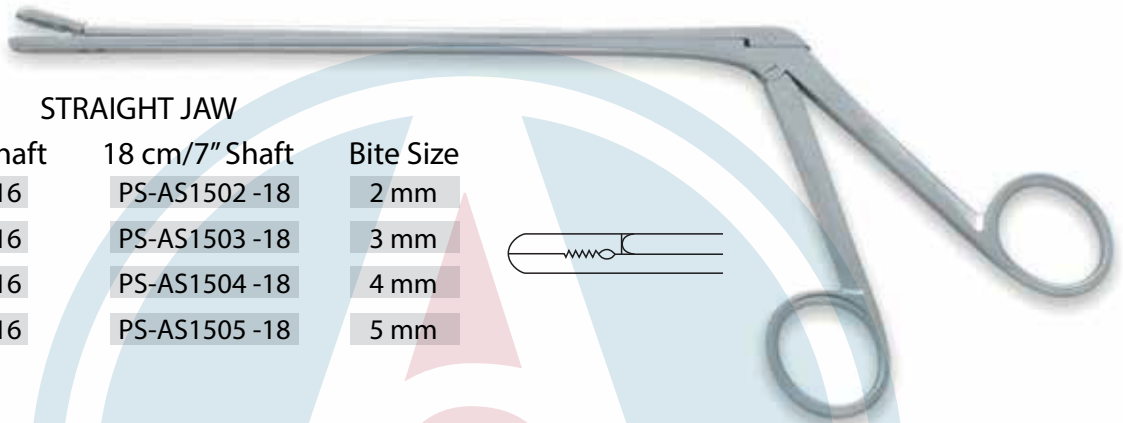
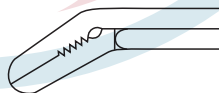

Schlesinger Toothed Rongeur

STRAIGHT JAW

15 cm/6" Shaft	18 cm/7" Shaft	Bite Size
PS-AS1210 -15	PS-AS1210 -18	2 mm
PS-AS1310 -16	PS-AS1310 -18	3 mm
PS-AS1410 -16	PS-AS1410 -18	4 mm

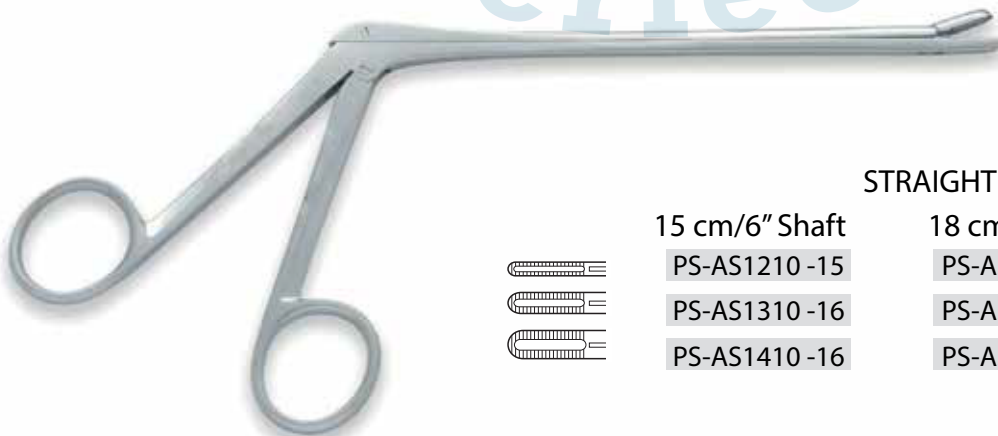
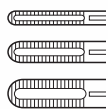

Surgicals & Instruments

Williams Discectomy Rongeur

DISC RONGEURS

14 cm/5½" Shaft

PS-AS 1110 -14

Longer pattern
23 cm/9" Shaft

PS-AS 1110 -23

- Short 10mm length jaw

- Single toothed cup 1mm bite

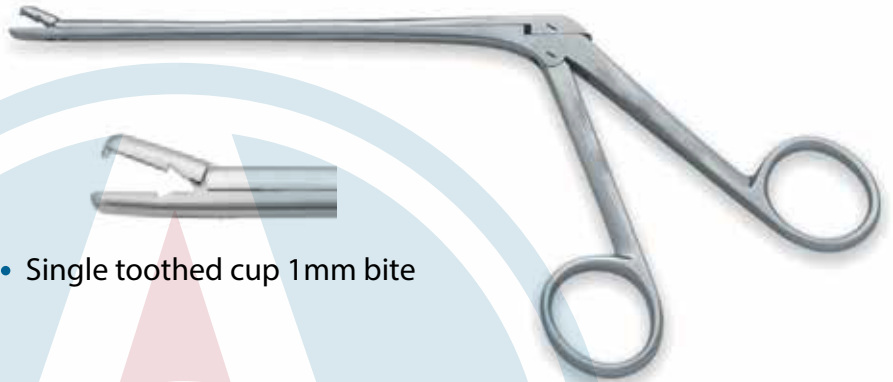

'Pea Pod' Disc Rongeur

- Short 10mm length jaw

15 cm/6" Bite Size

PS-AS 1510 -15 2mm

PS-AS 1610 -15 3mm

PS-AS 1710 -15 4mm

13 cm/5¼" Bite Size

PS-AS1510 -13 2mm

- Extra fine pattern 5mm length jaws

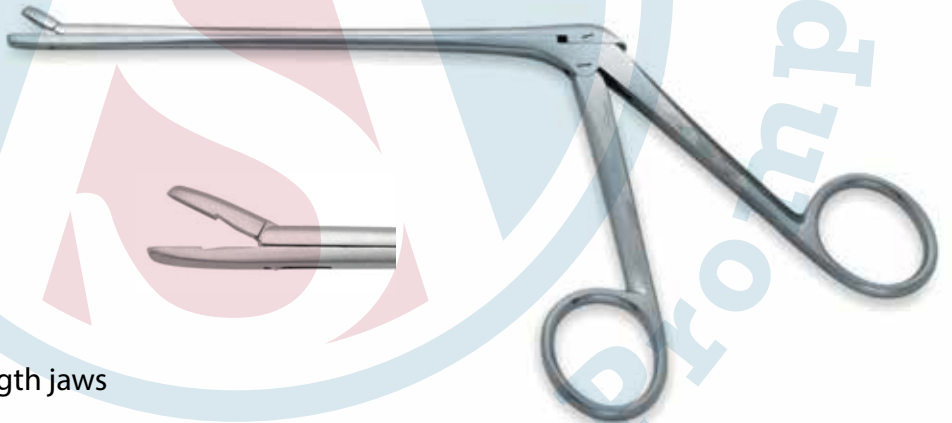

Beck Disc Rongeur

- 13 cm/5¼" Shaft
- 2 cm bite size

PS-AS 1910 -13



Surgicals & Instruments

Munich Grasping Forceps

DISC RONGEURS

- 118cm/7" Shaft length
- 1x 2 teeth
- Straight jaw

PS-AS1224 -18

- Toothed Serrated Jaw

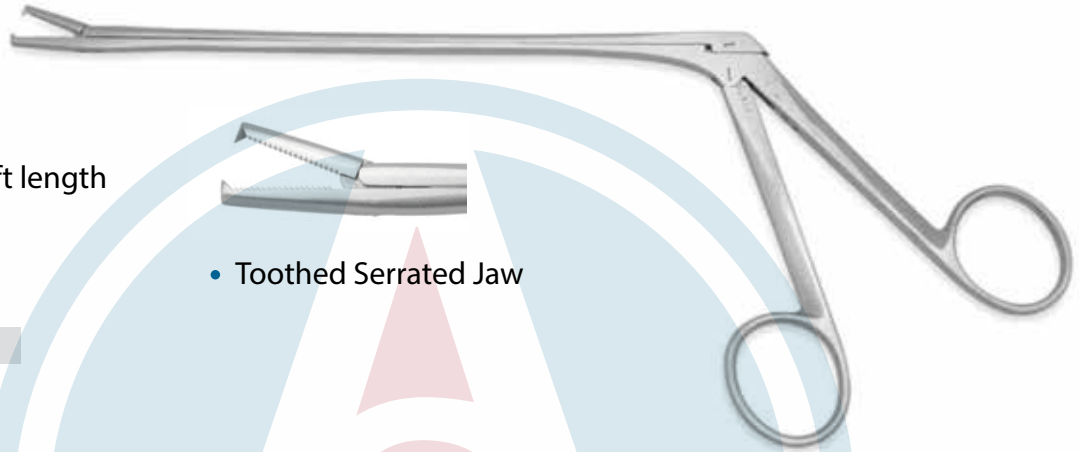

Decker Ronguer

- 15cm/6" working length
- Straight 6mm jaw

PS-AS1223 -15

- 1.5mm Jaw

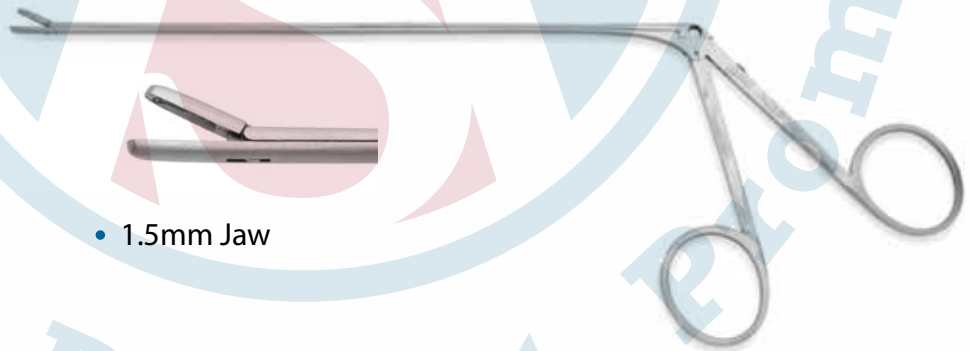

Nicola Micro Cupped Biopsy Forceps

- 16.5cm/6 1/2" Shaft

PS-AS1222 -16

16.5cm/6 1/2"



- Ø 2.5mm

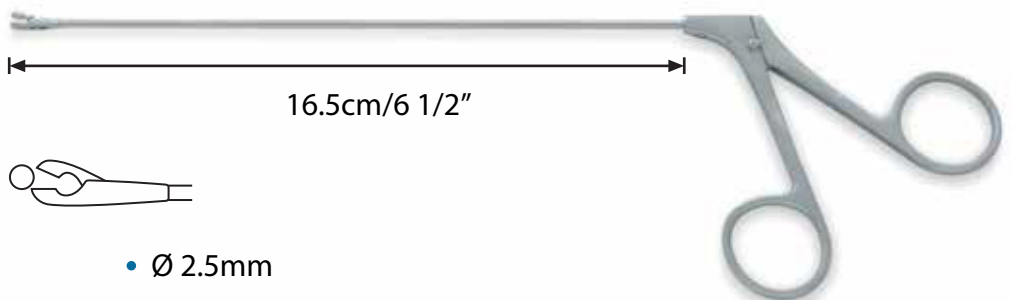

Surgicals & Instruments

DISC RONGEURS

'Clean Wave' Intervertebral Disc Rongeur

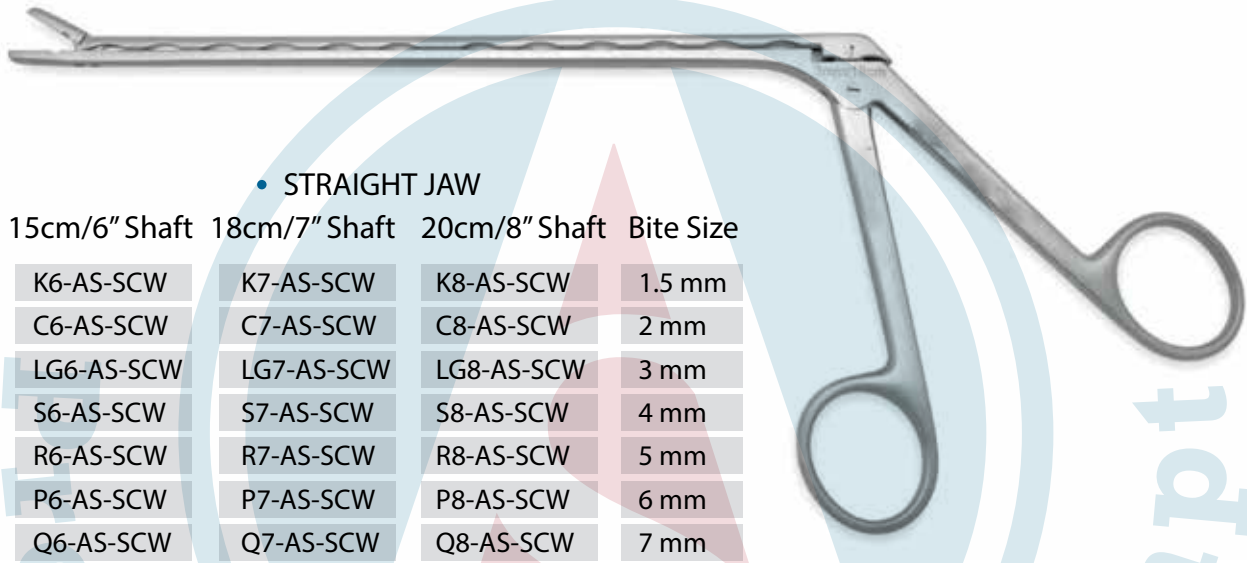

- STRAIGHT JAW

15cm/6" Shaft	18cm/7" Shaft	20cm/8" Shaft	Bite Size
K6-AS-SCW	K7-AS-SCW	K8-AS-SCW	1.5 mm
C6-AS-SCW	C7-AS-SCW	C8-AS-SCW	2 mm
LG6-AS-SCW	LG7-AS-SCW	LG8-AS-SCW	3 mm
S6-AS-SCW	S7-AS-SCW	S8-AS-SCW	4 mm
R6-AS-SCW	R7-AS-SCW	R8-AS-SCW	5 mm
P6-AS-SCW	P7-AS-SCW	P8-AS-SCW	6 mm
Q6-AS-SCW	Q7-AS-SCW	Q8-AS-SCW	7 mm

- 40 ANGLED UPWARD JAW

15cm/6" Shaft	18cm/7" Shaft	20cm/8" Shaft	Bite Size
K6-AS-SCW	K7-AS-SCW	K8-AS-SCW	1.5 mm
C6-AS-SCW	C7-AS-SCW	C8-AS-SCW	2 mm
LG6-AS-SCW	LG7-AS-SCW	LG8-AS-SCW	3 mm
S6-AS-SCW	S7-AS-SCW	S8-AS-SCW	4 mm
R6-AS-SCW	R7-AS-SCW	R8-AS-SCW	5 mm
P6-AS-SCW	P7-AS-SCW	P8-AS-SCW	6 mm
Q6-AS-SCW	Q7-AS-SCW	Q8-AS-SCW	7 mm

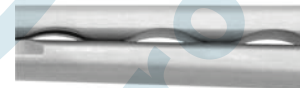

- Open design of shaft allows cleaning of shaft

- 40 ANGLED DOWNWARD JAW

15cm/6" Shaft	18cm/7" Shaft	20cm/8" Shaft	Bite Size
K6-AS-SCW	K7-AS-SCW	K8-AS-SCW	1.5 mm
C6-AS-SCW	C7-AS-SCW	C8-AS-SCW	2 mm
LG6-AS-SCW	LG7-AS-SCW	LG8-AS-SCW	3 mm
S6-AS-SCW	S7-AS-SCW	S8-AS-SCW	4 mm
R6-AS-SCW	R7-AS-SCW	R8-AS-SCW	5 mm
P6-AS-SCW	P7-AS-SCW	P8-AS-SCW	6 mm
Q6-AS-SCW	Q7-AS-SCW	Q8-AS-SCW	7 mm

Surgicals & Instruments

Ferris-Smith Disc Rongeur

- Ring handle

DISC RONGEURS



• STRAIGHT JAW

18cm/7" Shaft	20cm/8" Shaft	Bite Size
PSRS-AS 0072	PSRS-AS 0082	2 mm
PSRS-AS 0073	PSRS-AS 0082	3 mm
PSRS-AS 0074	PSRS-AS 0082	4 mm
PSRS-AS 0075	PSRS-AS 0082	5 mm



• 40 UPWARD JAW

18cm/7" Shaft	20cm/8" Shaft	Bite Size
PSRU-AS 0072	PSRU-AS 0082	2 mm
PSRU-AS 0073	PSRU-AS 0083	3 mm
PSRU-AS 0074	PSRU-AS 0084	4 mm
PSRU-AS 0075	PSRU-AS 0085	5 mm

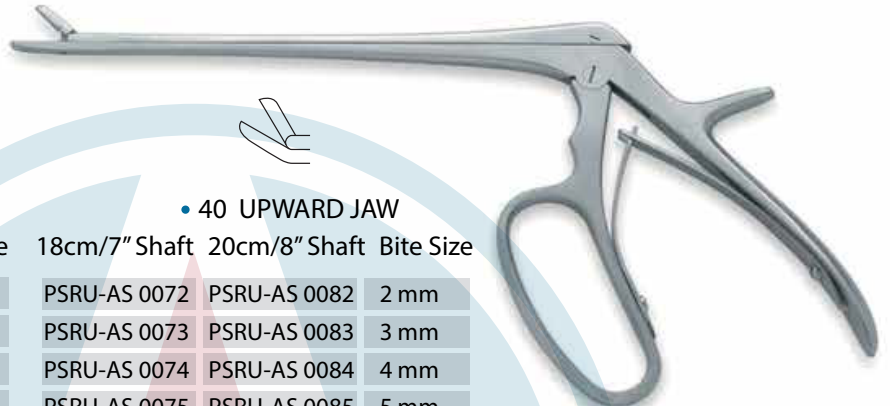

Anterior Disc Rongeur

- 28cm/11" Shaft
- Longer 28cm shaft for greater reach in the Anterior approach

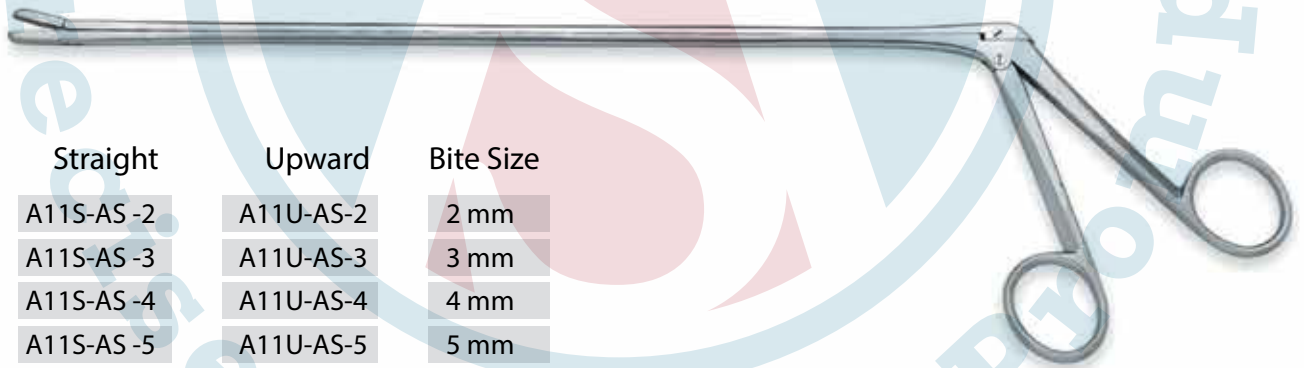

Straight	Upward	Bite Size
A11S-AS-2	A11U-AS-2	2 mm
A11S-AS-3	A11U-AS-3	3 mm
A11S-AS-4	A11U-AS-4	4 mm
A11S-AS-5	A11U-AS-5	5 mm

Anterior Long Rongeur

- 35cm/13 1/2" Shaft
- Extra long length shaft for deeper areas

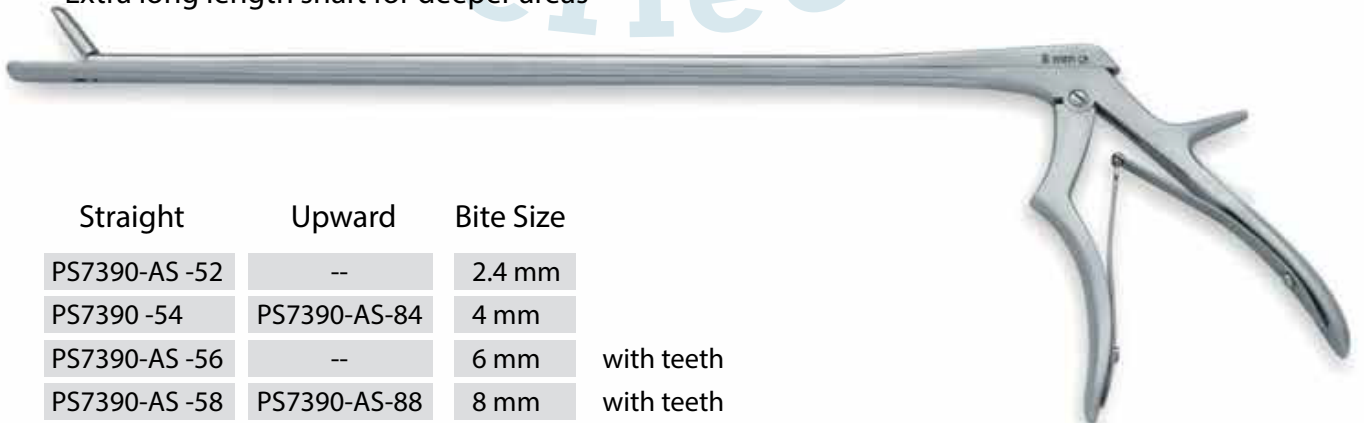

Straight	Upward	Bite Size	
PS7390-AS -52	--	2.4 mm	
PS7390 -54	PS7390-AS-84	4 mm	
PS7390-AS -56	--	6 mm	with teeth
PS7390-AS -58	PS7390-AS-88	8 mm	with teeth

Surgicals & Instruments

BONE NIBBLERS & CUTTERS

Lempert Bone Nibbler

- Single Action
- 19cm/7 1/2"

3mm Bite
PS1001-19

PS-AS 1001-19

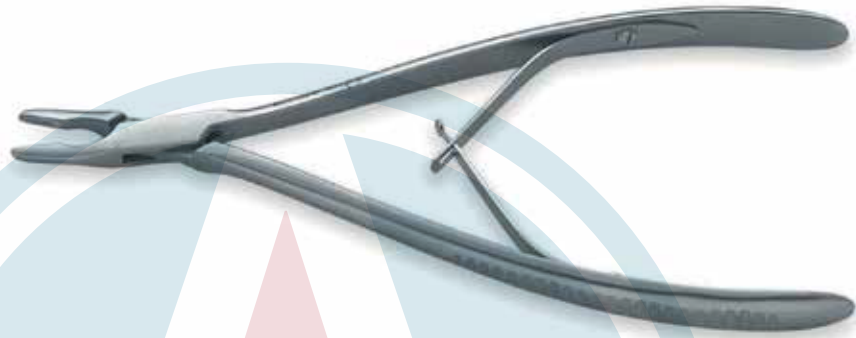

Luer Bone Nibbler

- Single Action
- 18cm/7"

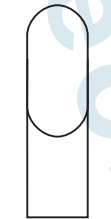

Straight
8mm Bite

PS-AS 1004-18



Curved
8mm Bite

PS-AS 1005-18

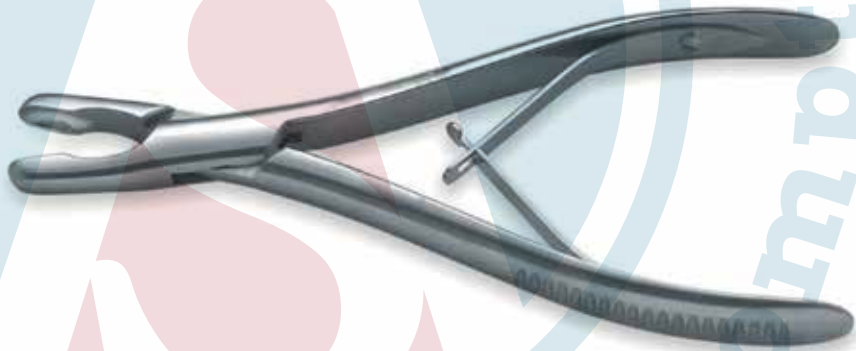

Adsons Bone Nibbler

- Single Action
- 20cm/8"



7mm Bite

PS-AS 1040-20

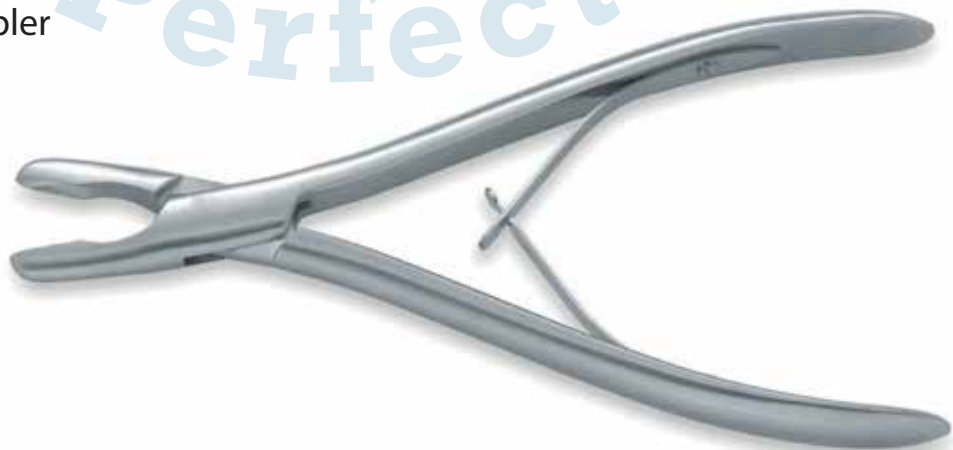

Surgicals & Instruments

BONE NIBBLERS & CUTTERS

Pennybacker Bone Nibbler

- Single Action
- 20cm/8"



4mm Bite

PS-AS 1041-20

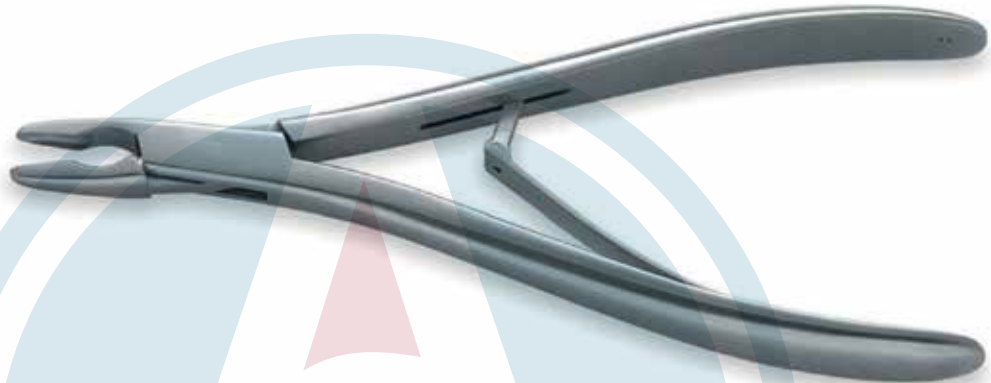

Northfields Bone Nibbler

- Single Action
- 20cm/8"



10mm Bite

PS-AS 1042-20

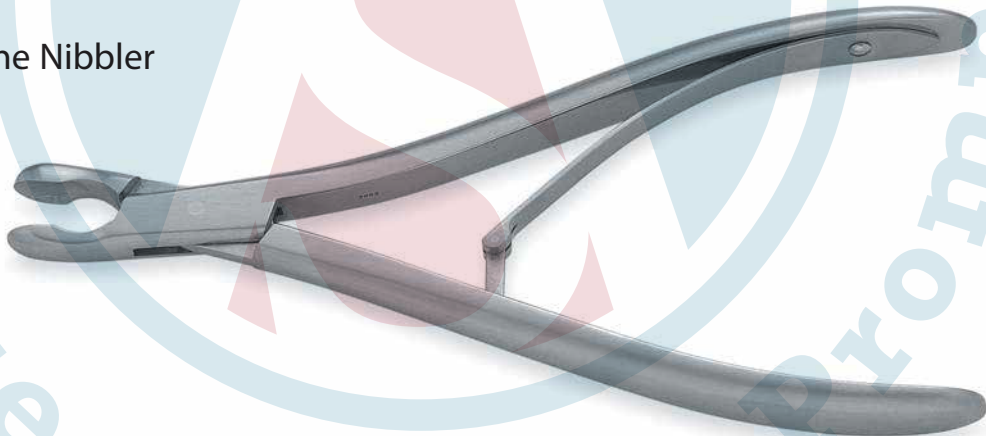

'Rat Toothed' Bone Nibbler

- Single Action
- 21cm/8 1/4"

PS-AS 1031-21

8mm Bite



- 3 x 3 Teeth

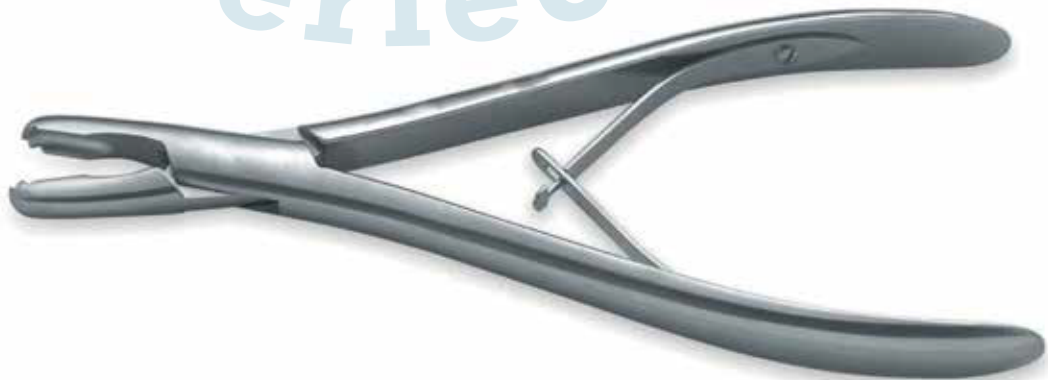

Surgicals & Instruments

BONE NIBBLERS & CUTTERS

Zielke Intervertebral Rongeur

- Angled Parallel Jaws

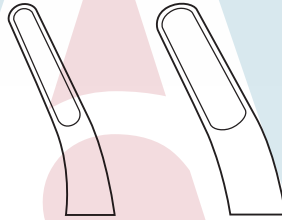
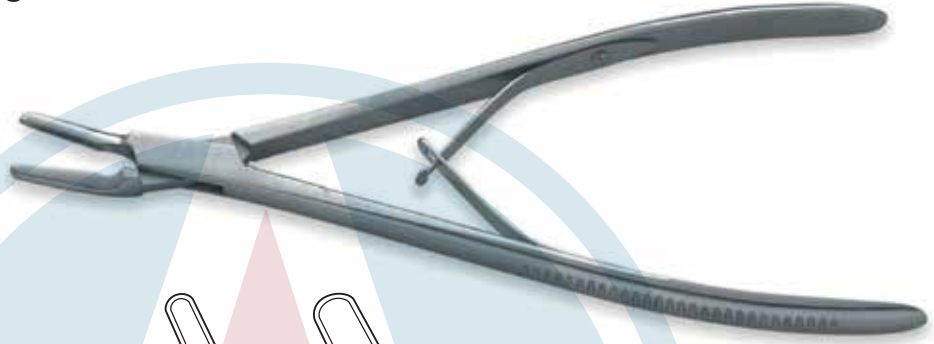

3mm Bite

5mm Bite

21cm/8¼" 25cm/9¾" BiteSize

PS-AS 1026 - 21 PS-AS 1026 - 25 3mm

PS-AS 1027 - 21 PS-AS 1027 - 25 5mm

Zielke Intervertebral Rongeur

- 20cm/8"
- Angled Jaws

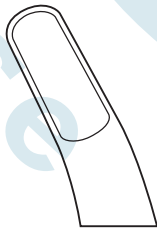
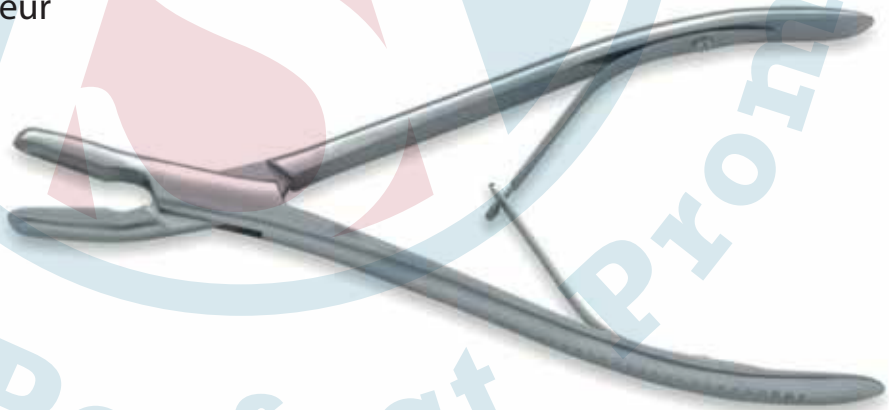

8mm Bite

PS-AS 1043-20

Beyer Bone Nibbler

- Curved Double Action
- 18cm/7"

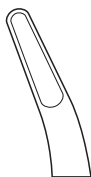

4mm Bite

PS-AS 1002-18

Surgicals & Instruments

BONE NIBBLERS & CUTTERS

Jansen Bone Nibbler

- Curved Double Action
- 18cm/7"

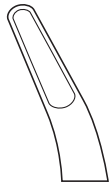

5mm Bite

PS-AS 1003-18



Marquardt Bone Nibbler

- Curved Double Action
- 20cm/8"



3mm Bite

PS-AS 1002-20

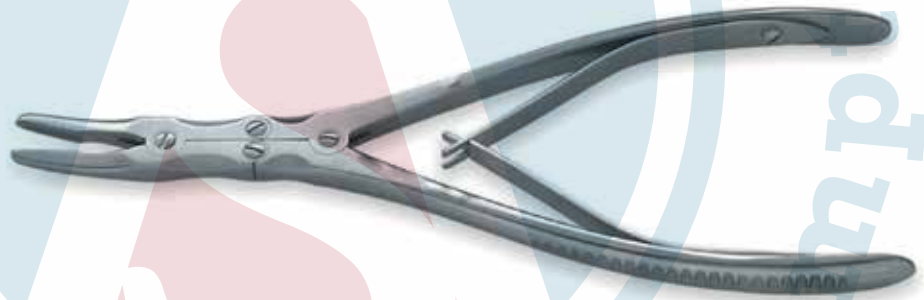

Smith-Peterson Bone Nibbler

- Double Action
- 24cm/9½"



Straight	Light Curve	Bite Size
PS-AS 1010-24	PS-AS 1014-24	3mm
PS-AS 1011-24	PS-AS 1015-24	4mm
PS-AS 1012-24	PS-AS 1016-24	5mm
PS-AS 1013-24	PS-AS 1010-27	6mm



Straight

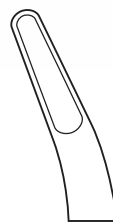

Light Curve

Surgicals & Instruments

Stille-Luer Bone Nibbler

- Double Action
- 22cm/8¾"

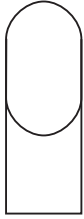

Straight
10mm Bite

PS-AS 1006-22



Curved
10mm Bite

PS-AS 1007-22

BONE NIBBLERS



Leksell Bone Nibbler

- Double Action Angled
- 24cm/9½"

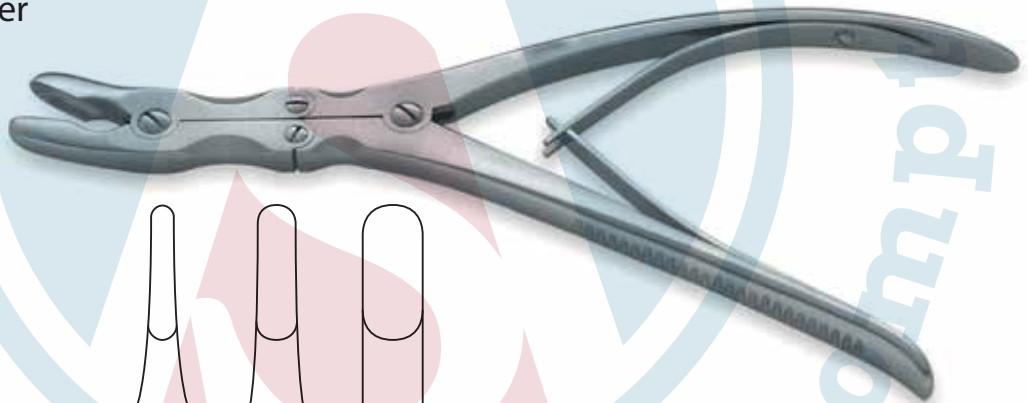

Angled Jaw Bite Size

PS-AS 1018-24 3mm

PS-AS 1019-24 4mm

PS-AS 1020-24 5mm



3mm



5mm



8mm

'Mr Blobby' Stille-Luer Bone Nibbler

- Double Action
- 26cm/10¼"

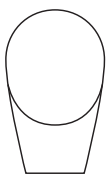

Straight
17mm Bite

PS-AS 1002-20



Curved
17mm Bite

PS-AS 1002-20



Surgicals & Instruments

Echlin Duckbill Nibbler

- Double Action
- 23cm/9"

BONE NIBBLERS



2mm Bite

PS-AS 1044-23



3mm Bite

PS-AS 1045-23



4mm Bite

PS-AS 1046-23

Long Anterior Leksell Bone Nibbler

- Double Action
- 30cm/12"

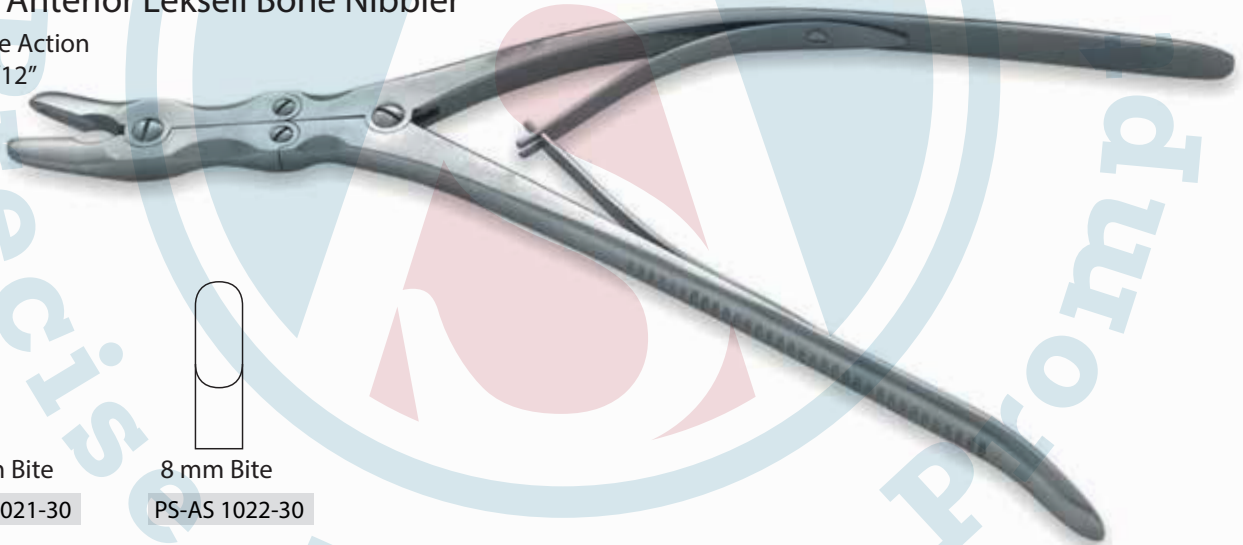

5mm Bite

PS-AS 1021-30



8 mm Bite

PS-AS 1022-30

Syptert Bone Nibbler

- Double Action - Very Long
- 36cm/14¼"



5mm Bite

PS-AS 1031-36



8 mm Bite

PS-AS 1032-36

Surgicals & Instruments

McIndoe Bone Cutters

- 18cm/7"



PS-AS 1028-18

BONE CUTTERS



Stille-Liston Bone Cutters

- 27cm/10 3/4"



Straight

PS-AS 1024-27



Angled

PS-AS 1025-27



Liston-Key-Horsley Bone Cutters

- 27cm/10 3/4"



PS-AS 1023-27

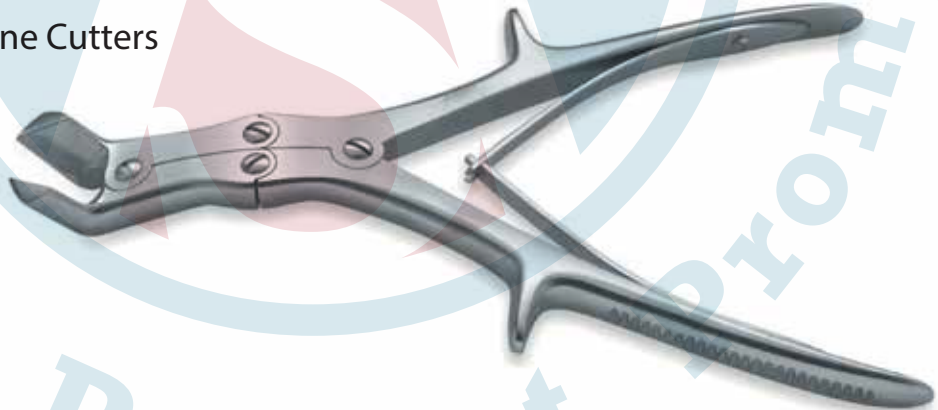

Tudor Edwards/Vehmehren Costotome

- 24cm/9 1/2"
- For cutting ribs

PS-AS 1023-24



Surgicals & Instruments

Dahmen Tufnol Handle
Osteotome

OSTEOTOMES

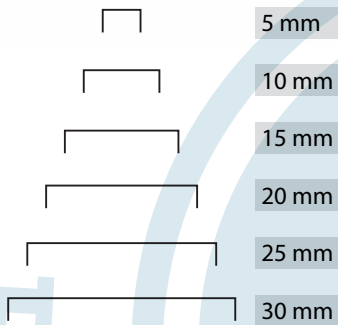

Straight	Width
PS-AS 7105-30	5 mm
PS-AS 7110-30	10 mm
PS-AS 7115-30	15 mm
PS-AS 7120-30	20 mm
PS-AS 7125-30	25 mm
PS-AS 7130-30	30 mm

Angled	Width
PS-AS 7305-30	5 mm
PS-AS 7310-30	10 mm
PS-AS 7315-30	15 mm
PS-AS 7320-30	20 mm
PS-AS 7325-30	25 mm
PS-AS 7330-30	30 mm

Lexer Tufnol Handle Osteotome

• 22cm/8 3/4"

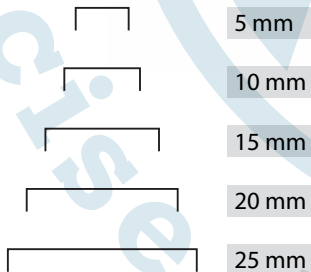

PS-AS 7207-22	7 mm
PS-AS 7210-22	10 mm
PS-AS 7215-22	15 mm
PS-AS 7220-22	20 mm
PS-AS 7225-22	25 mm

Stille Osteotome

• 22cm/8 3/4"

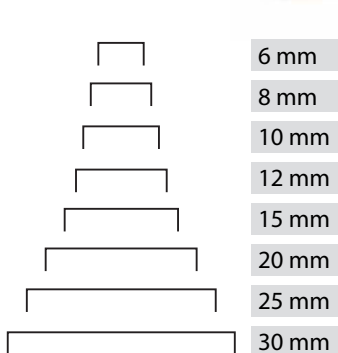

	Width
PS-AS 7706-20	6 mm
PS-AS 7708-20	8 mm
PS-AS 7710-20	10 mm
PS-AS 7712-20	12 mm
PS-AS 7715-20	15 mm
PS-AS 7720-20	20 mm
PS-AS 7725-20	25 mm
PS-AS 7730-20	30 mm

Surgicals & Instruments

OSTEOTOMES & MALLETS

Scaglietti Straight Osteotome Set

PS-AS 7452-00

Complete set consisting of:

Qty	Order Code	Description
6 mm		Scaglietti Osteotomes - 5 sizes
8 mm	PS-AS 7420-90	Instrument Case



Scaglietti Osteotomes

- 26cm/10 ¼"

	Size
PS-AS 7452-06	6 mm
PS-AS 7452-09	9 mm
PS-AS 7452-12	12 mm
PS-AS 7452-16	16 mm
PS-AS 7452-19	19 mm

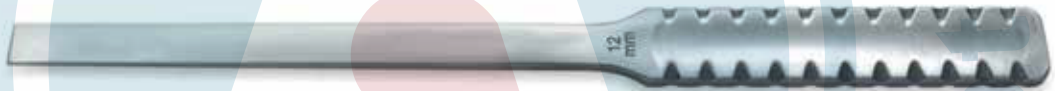

Toffee Mallet

- 19 cm/7 ½"
- Head size 22mm Ø
- Weight 165g/6oz

PS-AS 5802-18



London Splint Mallet

- 18 cm/7"
- Head size 30mm Ø
- Weight 450g/16.2oz

PS-AS 5802-18



Surgicals & Instruments

MALLETS

Heath Mallet

- 19 cm/7 ½"
- Stainless steel head
- Head size 40mm Ø
- Weight 1020g/36oz

PS-AS 5809-19

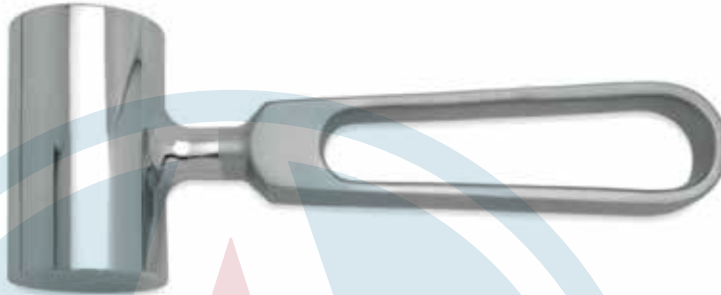

Mallet with Tufnol Handle

- 23cm/9"
- Head size 35mm Ø
- Weight 550g/20oz

PS-AS 5804-23



Ombredanne Mallet

- 24 cm/9 ½"
- Head size 40mm Ø
- Weight 550g/20oz

PS-AS 5806-24



Tufnol Mallet

- 25.5cm/10"
- Head size 42mm Ø
- Weight 250g/10oz

PS-AS 5807-25



Surgicals & Instruments

ELEVATORS & GOUGES

Adson Periosteal Elevator

- 16cm/6 1/4"
- Curved blunt

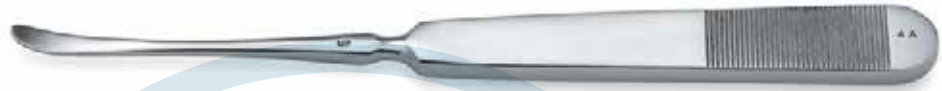

Width

SP-AS 3055-16	5 mm
SP-AS 3007-16	7 mm

Pennybacker Periosteal Elevator

- 16cm/6 1/4"
- Curved sharp



Width

PS-AS 3064-16	4 mm
SP-AS 3066-16	6 mm
SP-AS 3068-16	8 mm

Bone Raspatory with Tufnol Handle

- 19cm/7 1/2"



Width

PS-AS 7016 -19	6 mm
----------------	------



Curved

PS-AS 7023 -19	3 mm
PS-AS 7026 -19	6 mm

Width

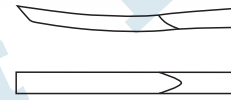

Farabeuf Rugine Elevator

- 5cm/6"



Straight Width

PS-AS 3001 -15	12 mm
----------------	-------

Curved* Width

PS-AS 3002 -15	12 mm
----------------	-------

* illustrated

Surgicals & Instruments

Adson Periosteal Elevator

ELEVATORS & GOUGES

- 16cm/6 ¼"
- Curved blunt



Width

SP-AS 3055-16	5 mm
SP-AS 3007-16	7 mm

Pennybacker Periosteal Elevator

- 16cm/6 ¼"
- Curved sharp



Width

PS-AS 3064-16	4 mm
SP-AS 3066-16	6 mm
SP-AS 3068-16	8 mm

Bone Raspatory with Tufnol Handle

- 19cm/7 ½"



Width

PS-AS 7016 -19	6 mm
----------------	------



Curved

PS-AS 7023 -19	3 mm
PS-AS 7026 -19	6 mm

Width

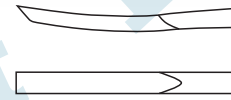

Farabeuf Rugine Elevator

- 5cm/6"



Straight Width

PS-AS 3001 -15	12 mm
----------------	-------

Curved* Width

PS-AS 3002 -15	12 mm
----------------	-------

* illustrated

Surgicals & Instruments

ELEVATORS & GOUGES

Trethowan Bone Lever

- 22.5cm/8 ½"

SP-AS 3030-22



Lanes Bone Lever

- 26cm/10 ¼"

PS-AS 3031-26

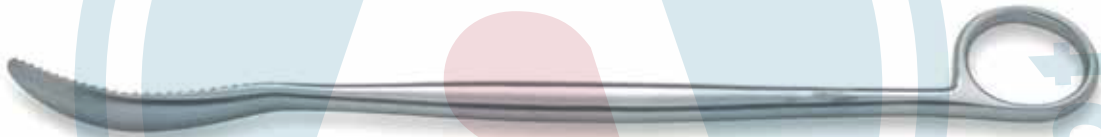

Fagge Bone Lever

- 7.5cm/10 ¾"

PS-AS 3032-27



Bristows Bone Elevator

- 23cm/9"



Straight Width

PS-AS 3003 -23 10 mm

Surgicals & Instruments

ELEVATORS & GOUGES

Hohmanns Bone Elevator

- 24cm/9 ¼"

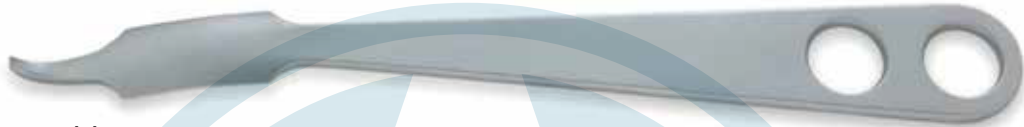

Width

PS-AS 3008 -22	8 mm
PS-AS 3018 -24	18 mm
PS-AS 3043 -24	43 mm

Inferior Hohmann Hip Retractor

- 40cm/16"
- 22mm width

PS-AS 3022-40



Zielke Gouge

- 23cm/9"

*illustrated



Curved*

Width

PS-AS 6520 - 23	6mm
PS-AS 6521 - 23	9mm

S-Shaped

Width

PS-AS 6522 - 23	6mm
PS-AS 6531 - 23	9mm

Capener Lamina Gouge

- 23cm/9"
- Cranked Shaft



Width

PS-AS 6506 - 23	6 mm
PS-AS 6508 - 23	68 mm
PS-AS 6511- 23	11 mm
PS-AS 6516- 23	16 mm

Surgicals & Instruments

BONE GRAFT IMPACTORS

Cervical Bone Graft Impactor 90° Offset

- 22cm/8 ½"

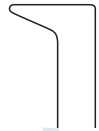

6mm x 12mm Tip

PS-AS 222-10



3.5mm x 6mm Tip

PS-AS 222-25

18cm length

Lumbar Bone Graft Impactor

- 22cm/8 ½"

PS-AS 3022-40

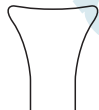

7mm x 12mm

PS-AS 222-40

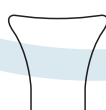

10mm x 13mm

PS-AS 222-50

Anterior Bone Graft Impactor

- 34cm/13 ½"

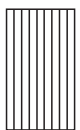

9 x 16mm Tip

PS-AS 7439-48

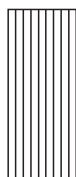

9 x 23mm Tip

PS-AS 7439-50

Surgicals & Instruments

Cobb Spinal Elevator

- 31cm/12 1/4" Overall length
- 18cm/7" Handle length

COBB ELEVATORS

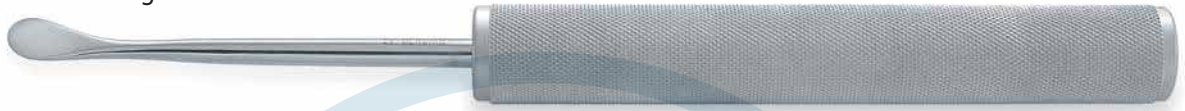

10 mm

PS-AS 7561-10



13 mm

PS-AS 7561-13

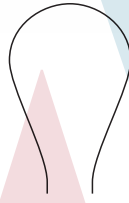

19 mm

PS-AS 7561-19

Harrington Cobb Spinal Elevator

- 30.5cm/12" Overall length

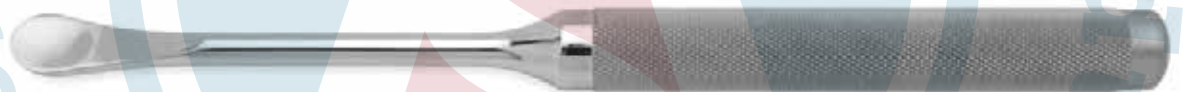

10 mm

PS-AS 7661-10



13 mm

PS-AS 7661-13



19 mm

PS-AS 7661-19

Cobb Spinal Elevator Extra Long Handle

- 34cm/13 1/2" Overall length
- 22cm/8 3/4" Handle length



10 mm

PS-AS 7662-10



15 mm

PS-AS 7662-15



20 mm

PS-AS 7662-20

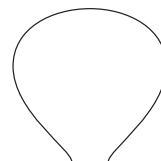

25 mm

PS-AS 7662-25

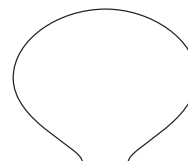

30 mm

PS-AS 7662-30

Surgicals & Instruments

Comfort Cobb Elevator

COBB ELEVATORS

- 32cm/12 ½" Overall length
- 20cm/8" Handle length



10 mm

PS-AS 7551-10



15 mm

PS-AS 7551-15

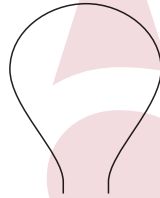

20 mm

PS-AS 7551-20

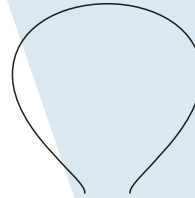

25 mm

PS-AS 7551-25

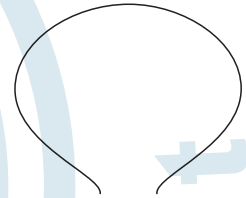

30 mm

PS-AS 7551-30

Long Anterior Comfort Cobb Elevator

- 47cm/18 ½"



10 mm

PS-AS 7551-50



15 mm

PS-AS 7551-55

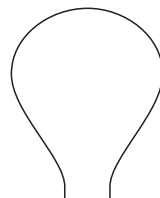

20 mm

PS-AS 7551-60

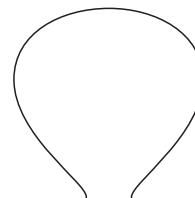

25 mm

PS-AS 7551-65

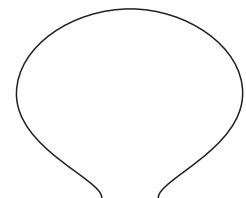

30 mm

PS-AS 7551-70

Surgicals & Instruments

BAYONET CERVICAL MICRO CURETTES

Cervical Micro Discectomy

- Curette Set

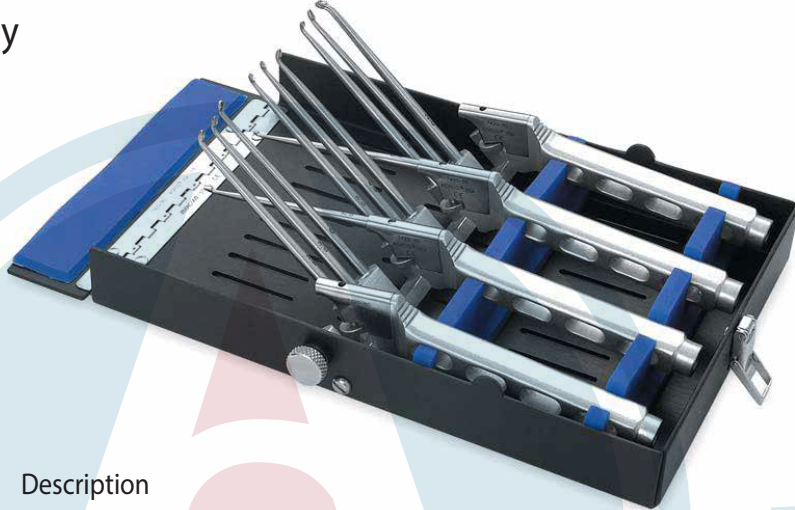

SP-AS 7420-00

Complete set consisting of:

Qty	Order Code	Description
4	SP-AS 7420-00	Curette Handles
12		Cervical Curette Shafts - includes: 5 Straight Shafts/5 Angled Shafts/2 Down Pushing Shafts
1	SP-AS 7420-00	Cervical Curette Shafts - includes:

Slim Micro Discectomy Curette Handle

SP-AS 7420-80



- Bayonet handled design for improved visualisation
- 360° rotating shafts are interchangeable
- Shaft length is adjustable
- Lightweight handle
- Instrument length: 23cm max. for standard curettes
- Shaft length 10cm

0000	0000	0000	0000	1	4 mm	5 mm
Cup	Cup	Cup	Cup	Cup	Cup	Cup
Size	Size	Size	Size	Size	Size	Size

Shaft Sizes

Straight Cup	Cup size	Forward Angle	Cup size	Down Pushing	Cup size
PS-AS 7420-50	00000	PS-AS 7422-50	00000	PS-AS 7424-20	00
PS-AS 7420-40	00000	PS-AS 7422-40	00000	PS-AS 7424-10	00
PS-AS 7420-30	0000	PS-AS 7422-30	0000		
PS-AS 7420-20	000	PS-AS 7422-20	000		
PS-AS 7420-10	00	PS-AS 7422-10	00		
	0		0		



Surgicals & Instruments

KARLIN STYLE BAYONET CERVICAL MICRO CURETTES

Bayonet Cervical Curette

- 21.5cm/8 1/2" overall length
- 9cm/3 1/2" shaft length



Straight Cup	Forward Angle	Cup size				
PS-AS 7418 - 10C	PS-AS 7418 - 12C	0	0	0	0	0
PS-AS 7418 - 20C	PS-AS 7418 - 22C	00	0000	000	00	0
PS-AS 7418 - 30C	PS-AS 7418 - 32C	000	Cup	Cup	Cup	Cup
PS-AS 7418 - 40C	PS-AS 7418 - 42C	0000	Size	Size	Size	Size

Long Bayonet Cervical Curette

- 24cm/9 1/2" overall length
- 12cm/4 1/2" shaft length



Straight Cup	Forward Angle	Cup size				
PS-AS 7418 - 10CL	PS-AS 7418 - 12CL	0	0	0	0	0
PS-AS 7418 - 20CL	PS-AS 7418 - 22CL	00	0000	000	00	0
PS-AS 7418 - 30CL	PS-AS 7418 - 32CL	000	Cup	Cup	Cup	Cup
PS-AS 7418 - 40CL	PS-AS 7418 - 42CL	0000	Size	Size	Size	Size

Container for 12 curettes

PS-AS 7418 - 98



Surgicals & Instruments

Lempert Curette

• 21cm/8 1/4"

SPINAL CURETTES



Straight Cup	Cup size	Straight Cup	Cup size	0000	0000	000	00	0	1 mm
PS-AS 8010 - 21	00000	PS-AS 8110 - 21	00000	Cup Size	Cup Size	Cup Size	Cup Size	Cup Size	Cup Size
PS-AS 8015 - 21	0000	PS-AS 8115 - 21	0000						
PS-AS 8020 - 21	000	PS-AS 8120 - 21	000						
PS-AS 8025 - 21	00	PS-AS 8125 - 21	00						
PS-AS 8030 - 21	0	PS-AS 8130 - 21	0						
PS-AS 8040 - 21	1	PS-AS 8140 - 21	1						

Bruns Curette

• 23cm/9"



Straight Cup	Cup size	Straight Cup	Cup size	000	00	0	1	2	3
PS-AS 8220 - 23	00000	PS-AS 8320 - 23	00000	Cup Size	Cup Size	Cup Size	Cup Size	Cup Size	Cup Size
PS-AS 8225 - 23	0000	PS-AS 8325 - 23	0000						
PS-AS 8230 - 23	000	PS-AS 8330 - 23	000						
PS-AS 8240 - 23	00	PS-AS 8340 - 23	00						
PS-AS 8250 - 23	0	PS-AS 8350 - 23	0						
PS-AS 8260 - 23	1	PS-AS 8360 - 23	1						

Tufnol Handle Micro Curette

• 27cm/10"



Straight Cup	Cup size	Straight Cup	Cup size	0000	000	00	0	1
PS-AS 8010 - 27	00000	PS-AS 8110 - 27	0000	Cup Size	Cup Size	Cup Size	Cup Size	Cup Size
PS-AS 8020 - 27	0000	PS-AS 8120 - 27	000					
PS-AS 8030 - 27	000	PS-AS 8130 - 27	00					
PS-AS 8040 - 27	00	PS-AS 8140 - 27	0					
PS-AS 8050 - 27	0	PS-AS 8150 - 27	1					

Surgicals & Instruments

Double Handled Extra Large Curette

- 38cm/15" Overall length
- 21cm/8 3/4" Handle length

SPINAL CURETTES



Straight	Cup size	Angled	Cup size
PS-AS 8807-34	7mm	PS-AS 8907-34	7mm
PS-AS 8809-34	9 mm	PS-AS 8909-34	9 mm
PS-AS 8811-34	11 mm	PS-AS 8911-34	11 mm
PS-AS 8813-34	13 mm	PS-AS 8913-34	13 mm
PS-AS 8815-34	15 mm	PS-AS 8915-34	15 mm

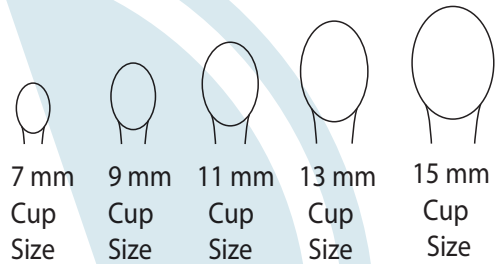

Comfort Handle Curette

- 29cm/11 1/2" overall length
- 20cm handle length



Straight	Cup size	Angled	Cup size
PS-AS 7561-07	6.5mm	PS-AS 8907-34	6.5mm
PS-AS 7561-09	8.5 mm	PS-AS 8909-34	8.5 mm
PS-AS 7561-11	11 mm	PS-AS 8911-34	11 mm
PS-AS 7561-13	13 mm	PS-AS 8913-34	13 mm
PS-AS 7561-15	15 mm	PS-AS 8915-34	15 mm

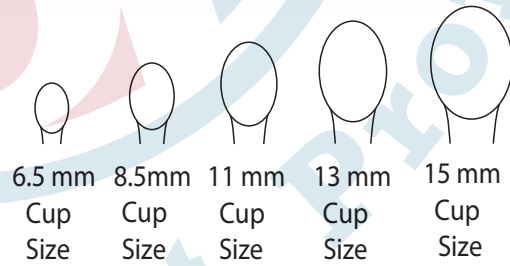

Long Anterior Curette

- 38cm/15" overall length

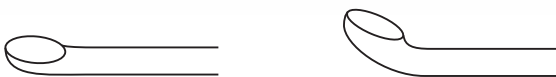

Straight	Cup size	Angled	Cup size
PS-AS 8043-38	4.3mm	PS-AS 8143-38	4.3mm
PS-AS 8070-38	7 mm	PS-AS 8170-38	7 mm
PS-AS 8080-38	8 mm	PS-AS 8180-38	8 mm

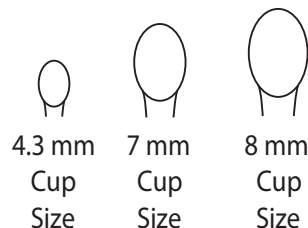

Surgicals & Instruments

Light-Grip Cervical Curettes

- 26cm/10 ¼" overall length
- 13cm/5 ¼" handle length
- Colour coded handles

SPINAL CURETTES



Cup Size	Straight	Forward	Down
6-0	PS-AS 7403-06	PS-AS 7405-06	PS-AS 7406-06
5-0	PS-AS 7403-05	PS-AS 7405-05	PS-AS 7406-05
4-0	PS-AS 7403-04	PS-AS 7405-04	PS-AS 7406-04
3-0	PS-AS 7403-03	PS-AS 7405-03	PS-AS 7406-03
2-0	PS-AS 7403-02	PS-AS 7405-02	PS-AS 7406-02
0	PS-AS 7403-01	PS-AS 7405-01	PS-AS 7406-01
1	PS-AS 7403-10	PS-AS 7405-10	PS-AS 7406-10
2	PS-AS 7403-20	PS-AS 7405-20	PS-AS 7406-20
3	PS-AS 7403-30	PS-AS 7405-30	PS-AS 7406-30
4	PS-AS 7403-40	PS-AS 7405-40	PS-AS 7406-40
5	PS-AS 7403-50	PS-AS 7405-50	PS-AS 7406-50
6	PS-AS 7403-60	PS-AS 7405-60	PS-AS 7406-60

Light-Grip Cervical Curette Rack

Holds 12 Cervical Curettes

PS-AS 7404-90

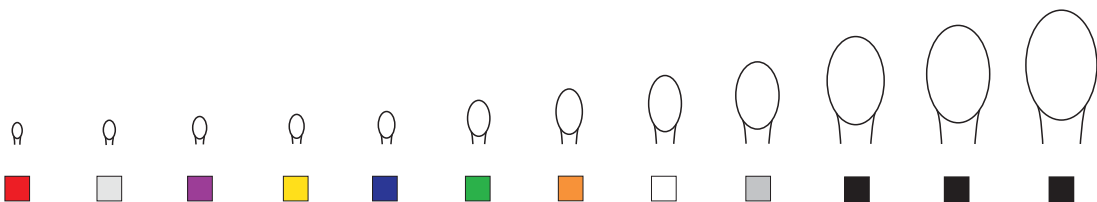



Surgicals & Instruments

Light-Grip Lumbar Currettes

- 34cm/13 1/2" overall length
- 20cm/8" handle length
- Colour coded handles

SPINAL CURETTES



Cup Size	Straight	Forward	Down
6-0	PS-AS 7407-06	PS-AS 7408-06	PS-AS 7409-06
5-0	PS-AS 7407-05	PS-AS 7408-05	PS-AS 7409-05
4-0	PS-AS 7407-04	PS-AS 7408-04	PS-AS 7409-04
3-0	PS-AS 7407-03	PS-AS 7408-03	PS-AS 7409-03
2-0	PS-AS 7407-02	PS-AS 7408-02	PS-AS 7409-02
0	PS-AS 7407-01	PS-AS 7408-01	PS-AS 7409-01
1	PS-AS 7407-10	PS-AS 7408-10	PS-AS 7409-10
2	PS-AS 7407-20	PS-AS 7408-20	PS-AS 7409-20
3	PS-AS 7407-30	PS-AS 7408-30	PS-AS 7409-30
4	PS-AS 7407-40	PS-AS 7408-40	PS-AS 7409-40
5	PS-AS 7407-50	PS-AS 7408-50	PS-AS 7409-50
6	PS-AS 7407-60	PS-AS 7408-60	PS-AS 7409-60

Light-Grip Lumbar Curette Rack Holds 12 Lumbar Currettes

PS-AS 7407-90

Cup Size	Cup Size	Cup Size	Cup Size	Cup Size	Cup Size	Cup Size	Cup Size	Cup Size	Cup Size	Cup Size	Cup Size
6-0	5-0	4-0	3-0	2-0	0	1	2	3	4	5	6
6-0	5-0	4-0	3-0	2-0	0	1	2	3	4	5	6

Surgicals & Instruments

SPINAL CURETTES

Cones Ring Curette

• 23cm/9"



Straight	Ring Size	Angled	Ring Size	
PS-AS 8803 - 23	3mm	PS-AS 8903 - 23	3mm	○ 3mm ring size
PS-AS 8806 - 23	6mm	PS-AS 8906 - 23	6mm	○ 6mm ring size
PS-AS 8806 - 23	8mm	PS-AS 8906 - 23	8mm	○ 8mm ring size

Zielke Curette

• 21cm/8¼"



Straight	Size	Angled	Size
PS-AS 8608 - 21	3mm	PS-AS 8708 - 21	3mm
PS-AS 8608 - 21	11mm	PS-AS 8708 - 21	11mm

Volkman Double Ended Curette

• 22cm/8¾"



Straight	Size			
PS-AS 8401-22	Small	○	○	○
PS-AS 8401-22	Medium	○	○	○
PS-AS 8401-22	Large	○	○	○
		Small	Medium	Large

Surgicals & Instruments

DISSECTORS

Swedish Dissector

- 8cm/7"

PS-AS 9201 -18



Howarth Elevator

- 21.5cm/8 1/2"

PS-AS 9207-21



MacDonald Elevator/Dissector

Size

PS-AS 9207-21 18cm/7"

PS-AS 9207-21 23cm/9"



Watson Cheyne Dissector

- 22cm/8 3/4"

Size

HA-A S7203 -18 18cm/7"

PS-AS 9203 - 23 23cm/9"

PS-AS 9203 - 25 25.5cm/10"



Freers Elevator/Dissector

- 18.5cm/7 1/4"

PS-AS 7602 -18



Surgicals & Instruments

CASPAR CERVICAL DISTRACTION SET

Caspar Vertebral Body Distraction Set

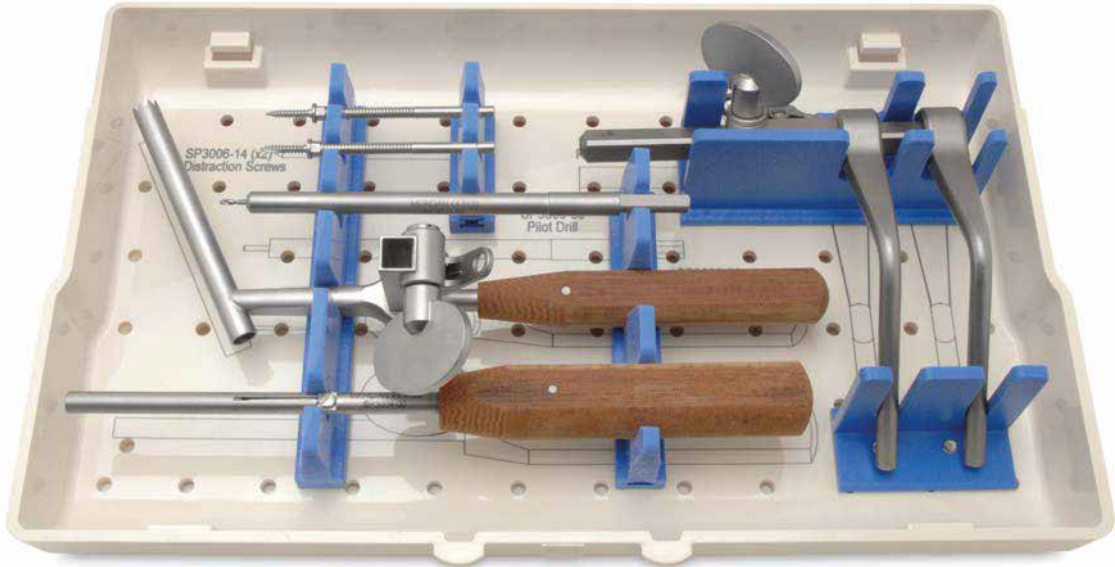

SP-AS 3001-00

- For retraction of the vertebral body in the cervical spine to allow access to the disc
- Less instrumentation in the disc space..
- Distraction screws are secured into the vertebral body either side of the disc, the retractor is then slid over the screws and retracted.

Complete set consisting of:

Qty	Order Code	Description
1	PS-AS 3002-00	Retractor Right
1	PS-AS 3003-00	Drill Guide Right
1	PS-AS 3004-00	Screw Driver
1	PS-AS 3005-00	Distraction Drill
1	PS-AS 3006-14	Sterile Distraction Screws 14mm

Distraction Retractor

SP-AS 3002 - 00 Right (illustrated)

SP-AS 3002 - 10 Left



Surgicals & Instruments

CASPAR CERVICAL DISTRACTION SET

Drill Guide

PS-AS 3003 - 00 Right (illustrated)

PS-AS 3003 - 10 Left



Screw Driver

PS-AS 3004 - 00



Distraction Drill

PS-AS 3005 - 00

- For pre-drilling pilot holes for screws with drill guide 2mm



Distraction Screws

- 7cm Post Length
- Sterile Packed



	Thread length
PS-AS 3002-00	12 mm
PS-AS 3003-00	14 mm
PS-AS 3004-00	16 mm

Surgicals & Instruments

LAMINA & VERTEBRAL SPREADERS

Cervical Vertebral Spreader

- 13cm/5 ¼"
- 3mm tip

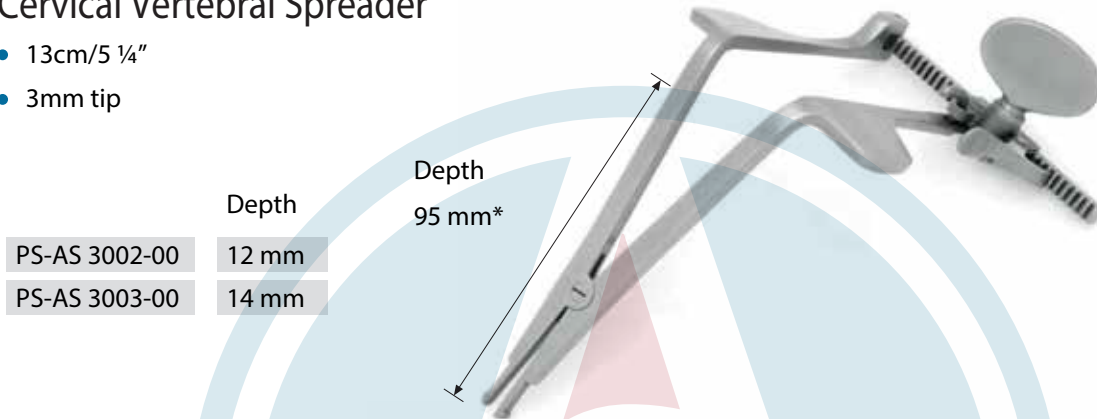

Cloward Cervical Spreader

- 17cm/6 ¾"
- Max opening 20mm

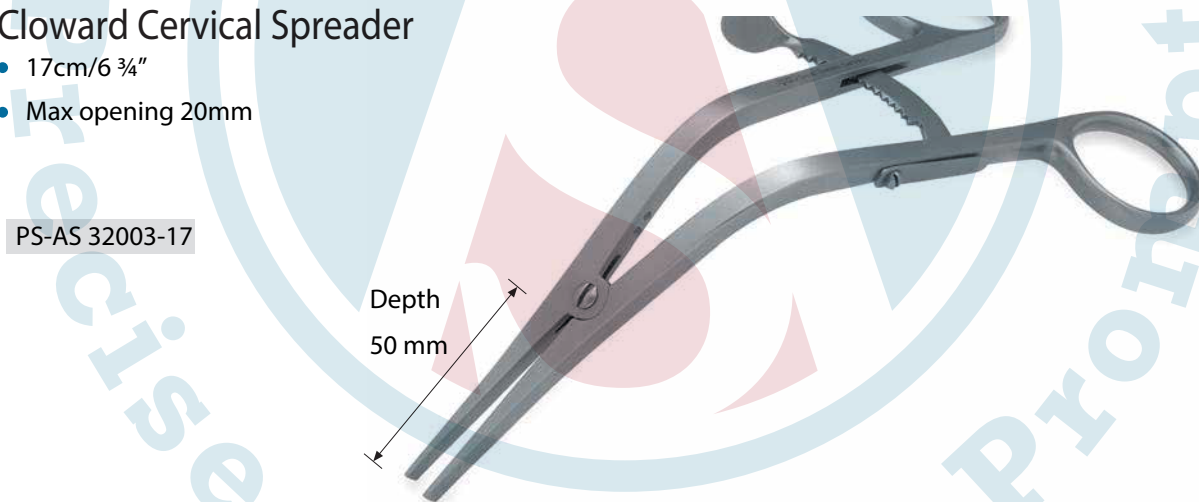

Cloward Lamina Spreader

- 715cm/6"



Surgicals & Instruments

LAMINA & VERTEBRAL SPREADERS

Baby Inge Lamina Spreader

- 18cm/7"

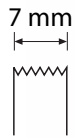

PS-AS 5134 -18

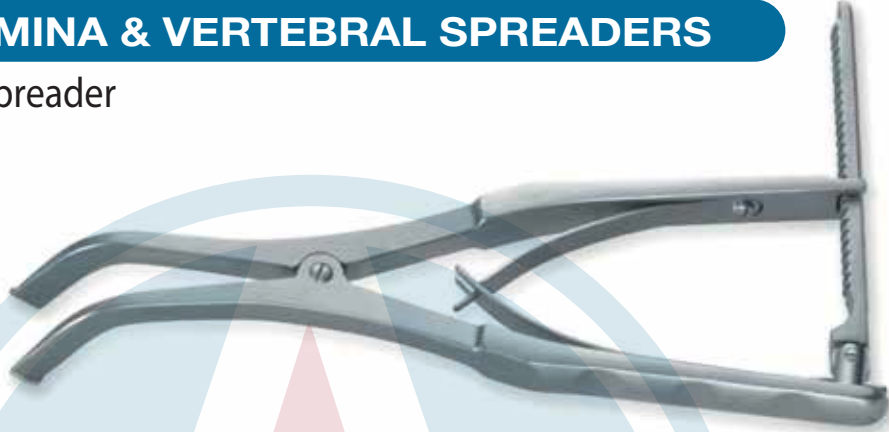

Inge Lamina Spreader

- 24cm/9 1/2", Max Opening 50mm

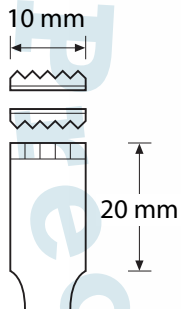

PS-AS 2006-24



Scaglietti Lamina Spreader

- 28cm/11"
- With speed lock



PS-AS 2009-28



Long Anterior Lamina Spreader

- 28cm/11"
- Max opening 40mm



PS-AS 2008-28



Surgicals & Instruments

HOOKS & PROBES

Adson Dural Hook

- 19cm/7 1/2"

Sharp

SP-AS 9103 -19

SP-AS 9104 -19



Titanium Micro Hooks

- 19cm/7 1/2"

90° Semi-Sharp

PS-AS 9103 -19

90° Blunt

MV-AS 9104 -19



Crile Blunt Hook

- 20 cm/8"
- 7mm tip length

PS-AS 9111- 20



Emmet Sharp Hook

- 22cm/8 3/4"
- 5mm tip length

PS-AS 9106- 22



Cushing Blunt Hook

- 22cm/11"
- 4mm tip length

PS-AS 9107- 28



Surgicals & Instruments

HOOKS & PROBES

Adson Hook

- 20cm/8"
- 5mm tip length



McCulloch Probe with Ball End

- 23.5cm/9 1/4"



Manipulation Hook

- 23.5cm/9 1/4"
- 4mm tip length



Blalock Blunt Hook

- 24cm/9 1/2"
- 5mm tip length



Caspar Exploration Probe

- 24.5cm/9 3/4"
- Insulated shaft

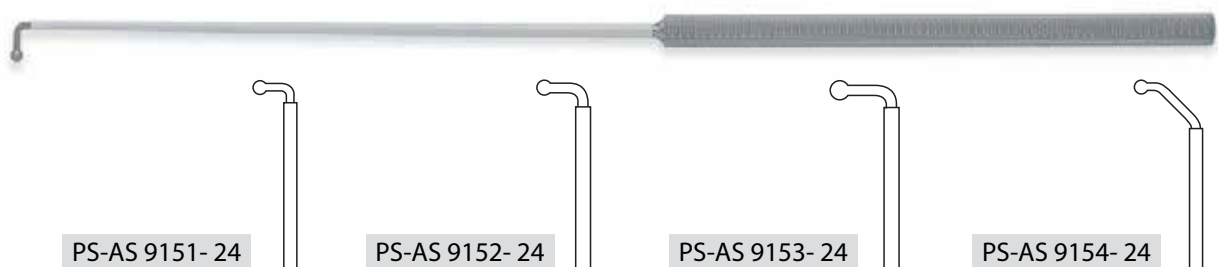

Surgicals & Instruments

NERVE ROOT RETRACTORS

Love Bayonet Nerve Root Retractor

- 21cm/8 ¼"



PS-AS 5000 -21

Krayenbuhl Nerve Root Retractor

- Double bayonet
- 21cm/8 ¼"



21cm/8 ¼"

24cm/9 ½"

PS-AS 5250 -13

PS-AS 5042 -24

O'Connell Nerve Root Retractor

- 21.5cm/8 ½"



PS-AS 5002 -21

Love Nerve Root Retractor

- 22cm/8 ¼"
- 5mm tip Width



PS-AS 5010 - 22

Straight

*illustrated

PS-AS 5011-22

25° Angled

PS-AS 5012 - 22

90° Angled

Surgicals & Instruments

NERVE ROOT RETRACTORS

Shepherd Suction Nerve Root Retractor

- 26cm/10 1/2"
- With suction aspiration
- Fibre optic illumination
- 4mm tip width

PS-AS 5015 - 26

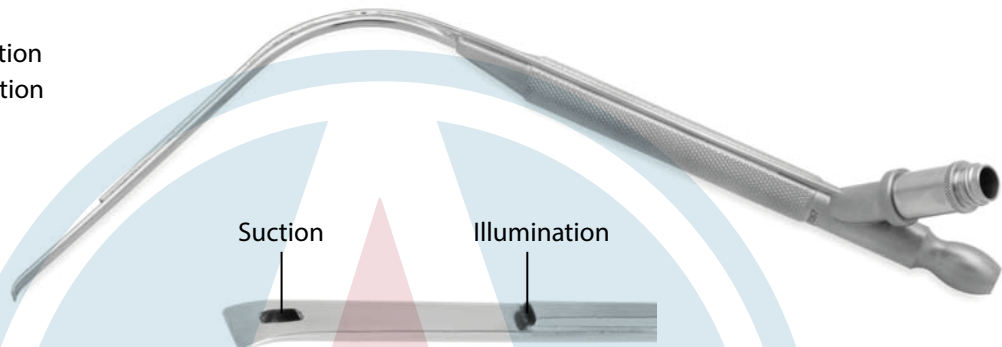

Nerve Root Retractor with suction

- 31cm/12"
- 7mm tip width

PS-AS 5013 - 31

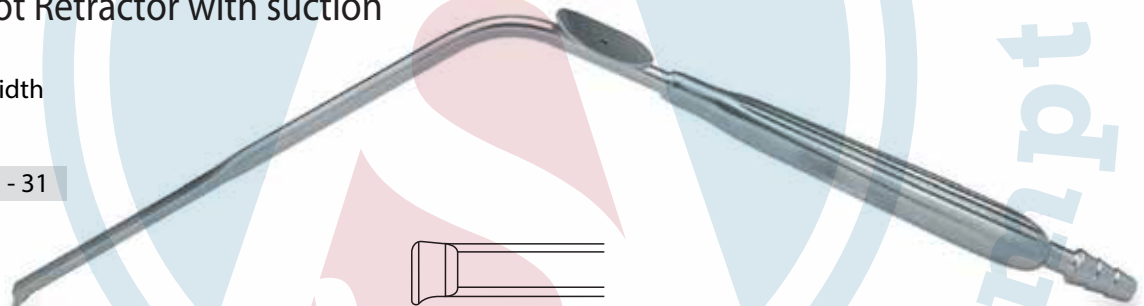

Hess Nerve Root Retractor

- 19cm/7 1/2"

	Width
PS-AS 5003 -19	3 mm
PS-AS 5004 -19	4 mm
PS-AS 5005 -19	5 mm
PS-AS 5007 -19	7 mm



	3 mm
	4 mm
	5 mm
	7 mm

Nerve Root Retractor

19cm/7 1/2"
With fibre optic illumination



	Width
PS-AS 5033 -19	3 mm
PS-AS 5055 -19	5 mm

Surgicals & Instruments

HAND HELD RETRACTORS

Meyerding Retractor

- 22.5cm/9"

Blade size

PS-AS 5050 - 22	50mm x 16mm
PS-AS 5075 - 22	75mm x 25mm
PS-AS 5090 - 22	90mm x 50mm

Langenbeck Retractor

- 21.5cm/8 1/2"

Blade size

PS-AS 5122 - 21	22mm x 6mm
PS-AS 5145 - 21	45mm x 13mm
PS-AS 5165 - 21	65mm x 20mm
PS-AS 5190 - 21	90mm x 20mm

Taylor Hip Retractor

- 19cm/7 1/2"

Depth

PS-AS 5006 - 19	70 mm
PS-AS 5008 - 19	85mm
PS-AS 5010 - 19	100 mm

Bone Hook

- 24.5cm/9 3/4"
- Sharp

PS-AS 9050 - 24

Volkman Catspaw Retractor

- Semi sharp teeth
- 21.5cm/8 1/2"



15 x 15mm
3 Prong

PS-AS 5015 - 21



15 x 20mm
4 Prong

PS-AS 5020 - 21

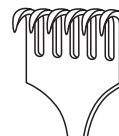

15 x 30mm
6 Prong

PS-AS 5030 - 21

Cloward Style Blade Retractor

- 11cm/4 1/4"

Width

PS-AS 5013 - 19	13 mm
PS-AS 5018 - 19	18 mm
PS-AS 5020 - 19	20 mm

Surgicals & Instruments

SELF RETAINING RETRACTORS

Baby Weitlaner S/R Retractor

- 11.5cm/4 ½"
- 2 x 3 Blunt Prongs

PS-AS 5701 -10

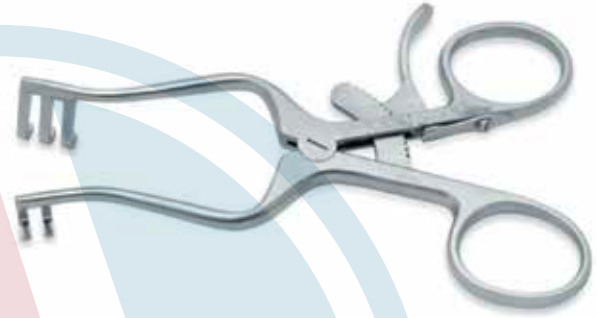

Mollison S/R Retractor - Child

- 13cm/5 ¼"
- 2 x 2 Sharp prongs 12mm depth

PS-AS 4005 -13



Mollison S/R Retractor - Adult

- 17cm/6 ¼"
- 4 x 4 Sharp prongs 14mm depth

PS-AS 4005-17



Surgicals & Instruments

SELF RETAINING RETRACTORS

Wests S/R Retractor

- 14cm/5 ½"
- 3 x 4 Sharp Prongs

PS-AS 4003 -14

Weitlaner S/R Retractor

- 14cm/5 ½"
- 3 x 4 Sharp Prongs

PS-AS 4002 -14

Travers S/R Retractor

- 20cm/8"
- 4 x 5 Blunt Prongs

PS-AS 4004 -20

Norfolk and Norwich S/R Retractor

- 20cm/8"
- 4 x 5 Blunt Prongs

PS-AS 4000 - 20

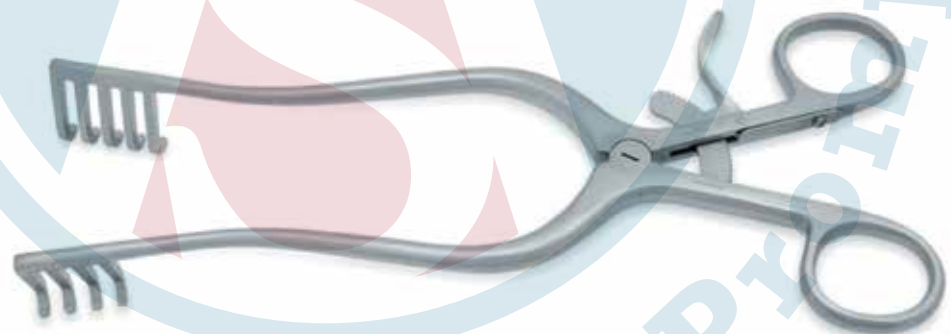
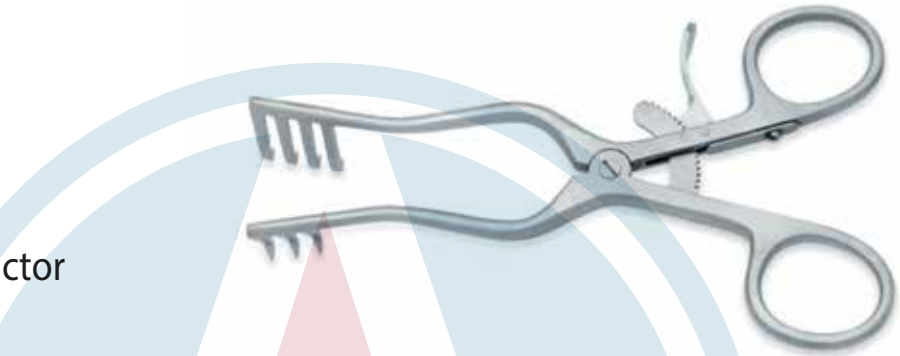

Surgicals & Instruments

SELF RETAINING RETRACTORS

Cones Self Retaining Retractor

- 3 x 4 Prongs
- Jointed Arms

PS-AS 4003 -14

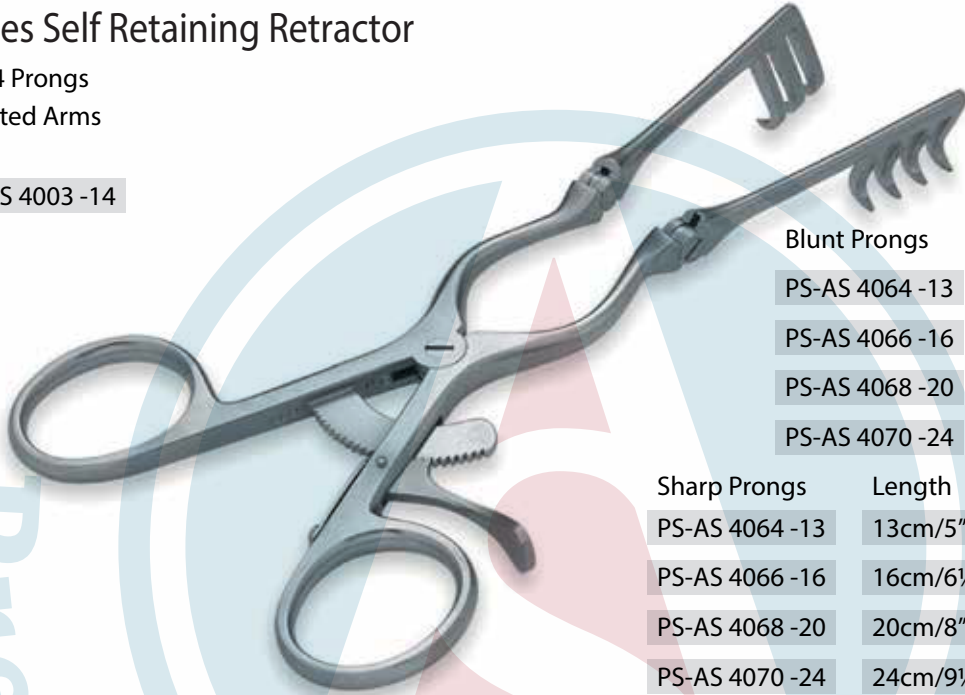

Blunt Prongs Length

PS-AS 4064 -13 13cm/5"

PS-AS 4066 -16 16cm/6½"

PS-AS 4068 -20 20cm/8"

PS-AS 4070 -24 24cm/9½"

Sharp Prongs Length

PS-AS 4064 -13 13cm/5"

PS-AS 4066 -16 16cm/6½"

PS-AS 4068 -20 20cm/8"

PS-AS 4070 -24 24cm/9½"

Beckman - Adson Retractor

- 31cm/12"
- 4 x 5 Blunt Prongs
- Jointed Arms

PS-AS 4001- 32 32mm Deep blades

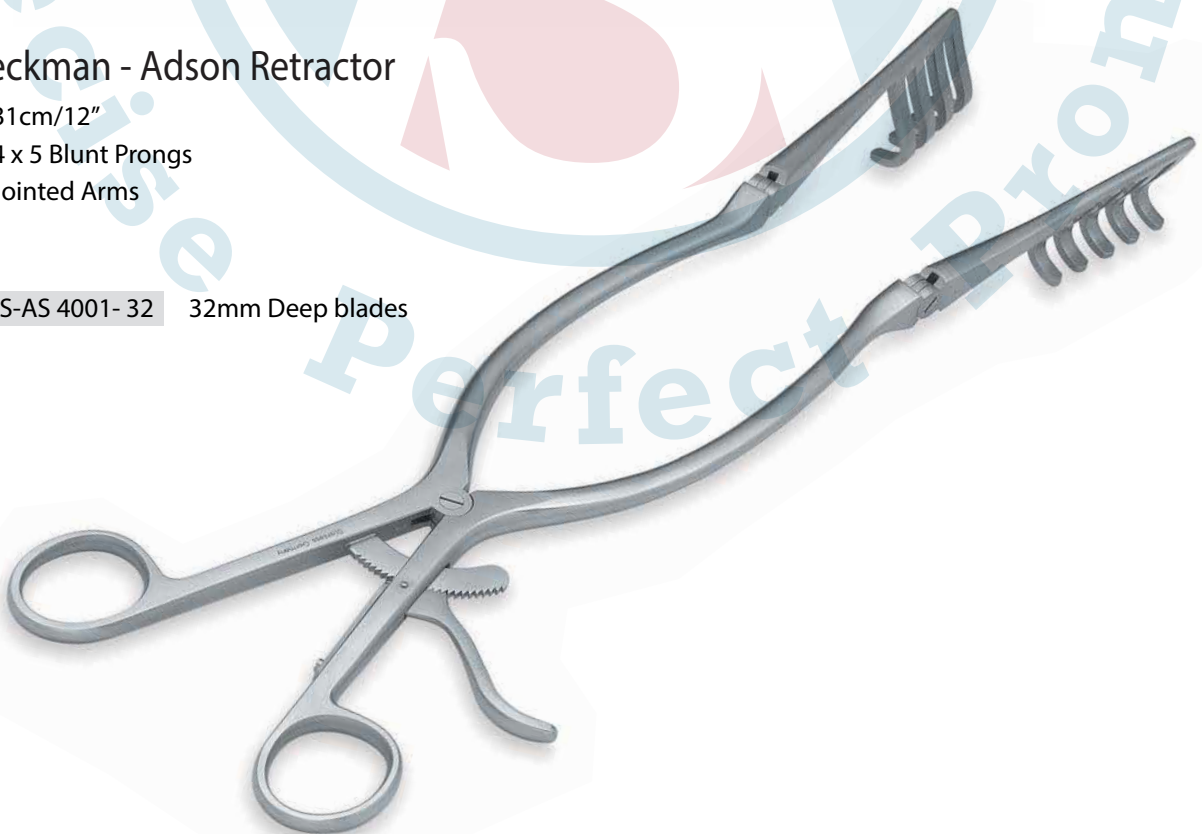

Surgicals & Instruments

SELF RETAINING RETRACTORS

Gelpi Laminectomy Retractor

- Sharp Prongs
- Jointed Arms

		Prong depth
• 18.5cm/7 1/4"	PS-AS 4030-16	30 mm
• 19.5cm/7 3/4"	PS-AS 4050-16	50 mm
• 20cm/8"	PS-AS 4070-16	70 mm



Hardman Retractor

- 20cm/8"

	Prong depth
PS-AS 4050 - 20	50mm equal prongs
PS-AS 4500 - 20	long prong - Left*
PS-AS 4300 - 20	long prong - Right

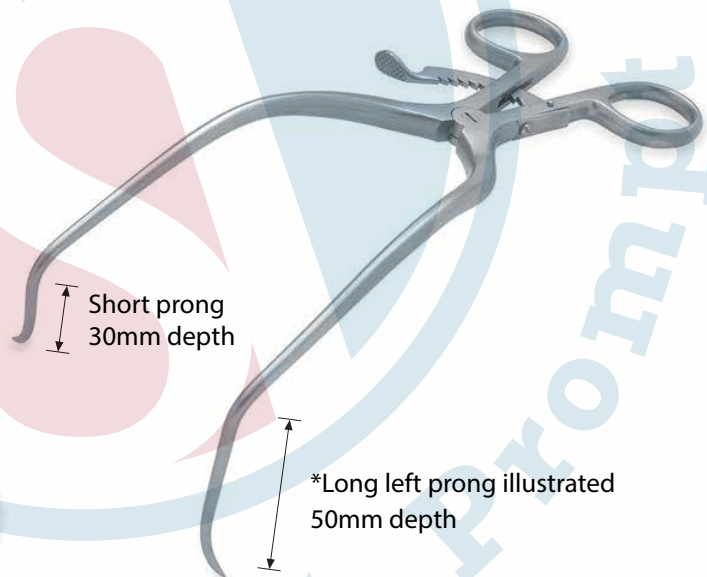

Meyerding Hemi Laminectomy Retractor

- 18cm/7"

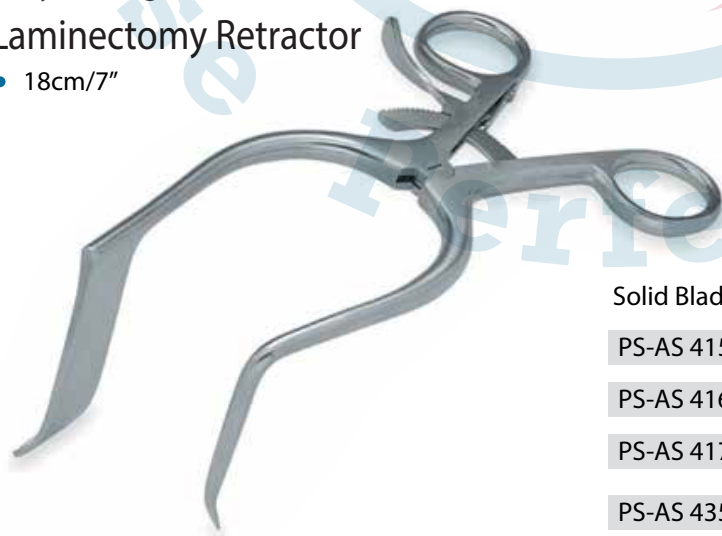

Solid Blade Left	Blade Size	Solid Blade Right	
PS-AS 4150 - 18	50 x 10mm	SP-AS 4250 - 18	Narrow Blade
PS-AS 4160 - 18	60 x 10mm	SP-AS 4260 - 18	
PS-AS 4170 - 18	70 x 10mm	SP-AS 4270 - 18	
PS-AS 4350 - 18	50 x 10mm	SP-AS 4250 - 18	Wide Blade
PS-AS 4360 - 18	60 x 10mm	SP-AS 4260 - 18	
PS-AS 4370 - 18	70 x 10mm	SP-AS 4270 - 18	

Surgicals & Instruments

SELF RETAINING RETRACTORS

Long Gelpi Orthopaedic Retractor

- 30cm/11¾"
- Sharp Prongs

Depth Prongs

PS-AS 7245 -10 70 mm

PS-AS 7245 -12 100 mm

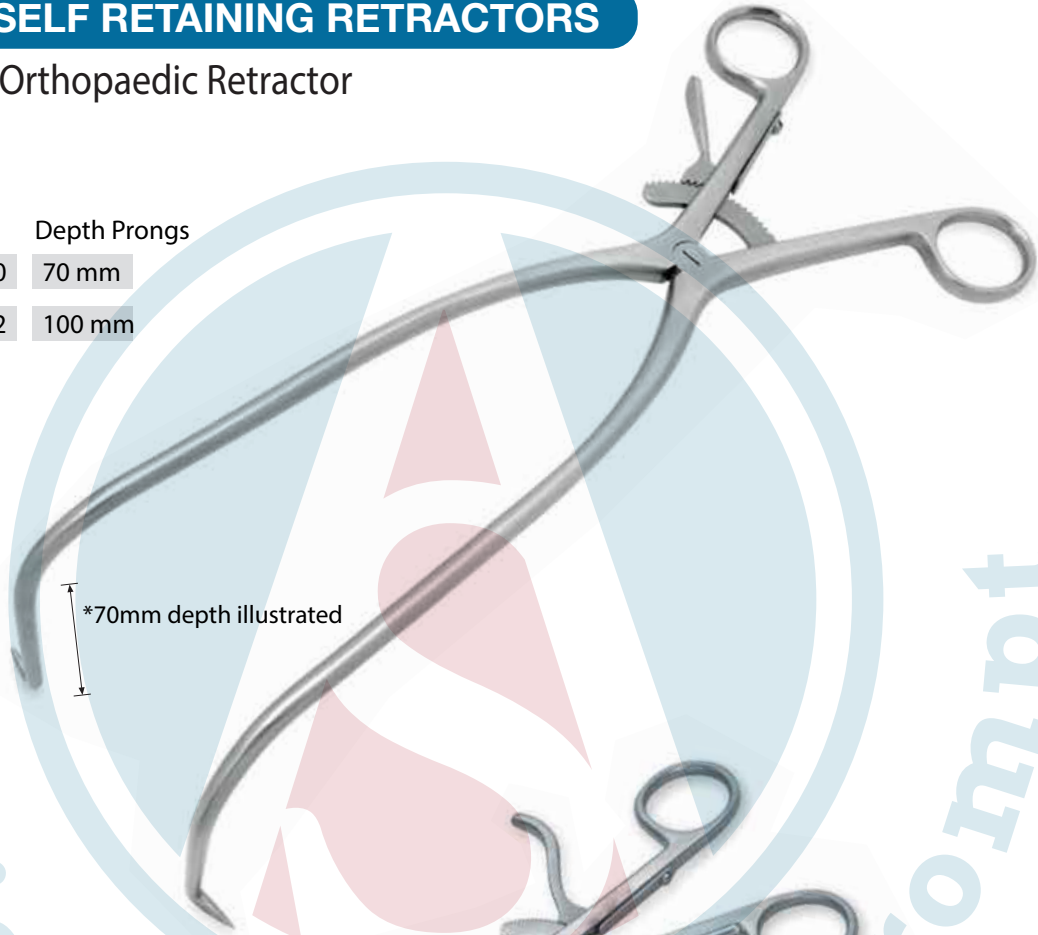

*70mm depth illustrated

Viper Scoliosis Retractor

- 30cm/11¾"
- Sharp Prongs

Depth Prongs

PS-AS 7248 - 38 40 mm

PS-AS 7248 - 40 70 mm

PS-AS 7248 - 50 100 mm

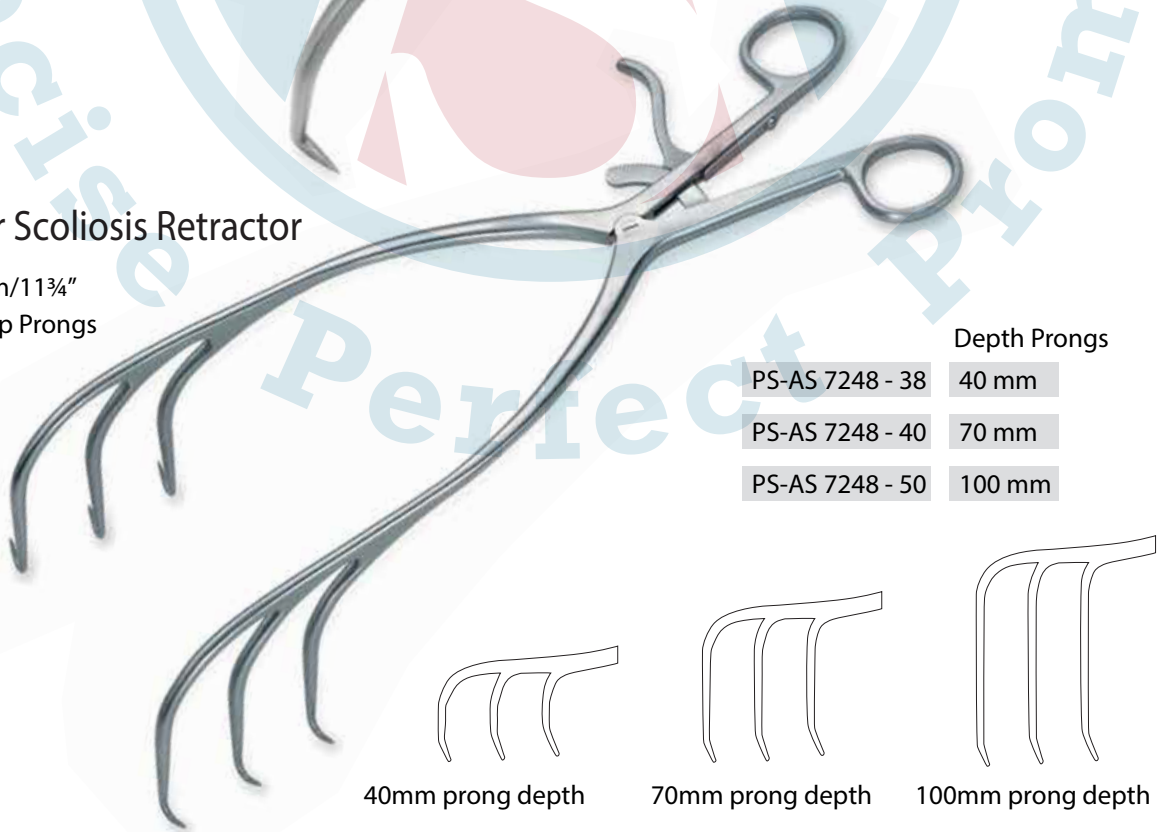

40mm prong depth

70mm prong depth

100mm prong depth

Surgicals & Instruments

MICRO DISCECTOMY RETRACTOR

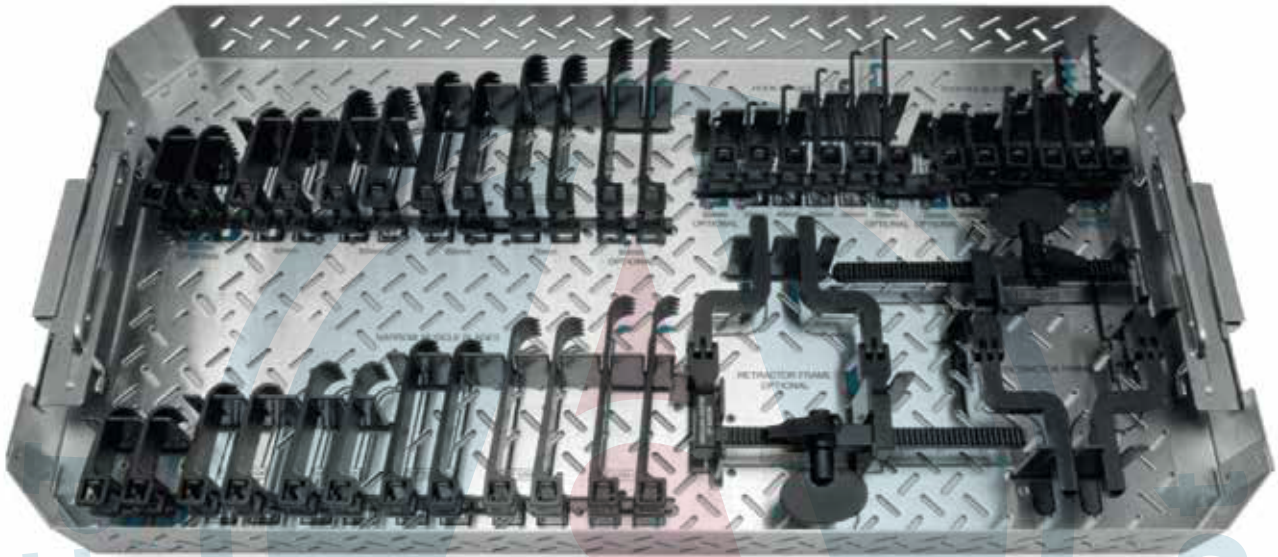

- This Specialist Retractor allows the Consultant the optimal exposure to the Disc with the minimum incision.
- The Design of the Retractor allows unhindered access around the wound with the jointed arms folding along the patients Back.

- The Black finish eliminates distracting reflections under the Microscope during Surgery.
- The wide selection of Blades available allows the Surgeon full flexibility in approaches to the Disc.

Basic Micro-Discectomy Retractor Set

PS-AS 5200 - 00

Complete set consisting of:

Qty	Order Code	Description
1 each	PS-AS 5202 - 00	Retractor Frame
4 pairs	PS-AS 5204 - 40	Wide Muscle Blades Sizes 4cm to 7cm depth
4 pairs	PS-AS 5206 - 40	Narrow Muscle Blades Sizes 4cm to 7cm depth
4 each	PS-AS 5208 - 40	Hook Blades Sizes 3cm to 6cm depth
4 each	PS-AS 5210 - 40	Toothed Blades Sizes 3cm to 6cm depth
1 each	PS-AS 5200 - 10	Instrument Container

Extended Micro-Discectomy Retractor Set

PS-AS 5200 - 01

Complete set consisting of:

Qty	Order Code	Description
1 each	PS-AS 5202 - 00	Retractor Frame
4 pairs	PS-AS 5204 - 40	Wide Muscle Blades Sizes 4cm to 7cm depth
4 pairs	PS-AS 5206 - 40	Narrow Muscle Blades Sizes 4cm to 7cm depth
4 each	PS-AS 5208 - 40	Hook Blades Sizes 3cm to 6cm depth
4 each	PS-AS 5210 - 40	Toothed Blades Sizes 3cm to 6cm depth
1 each	PS-AS 5200 - 10	Instrument Container

Surgicals & Instruments

MICRO DISSECTOMY RETRACTOR

Retractor Frame

- Jointed arms
- Maximum spread 70mm

PS-AS 5202 - 00

Retractor Frame

- Rigid arms

PS-AS 5203 - 00

(Frame available with extra long rack 140mm spread)



Hook Blades

PS-AS 5208 - 02	2 cm depth
PS-AS 5208 - 03	3 cm depth
PS-AS 5208 - 04	4 cm depth
PS-AS 5208 - 05	5 cm depth
PS-AS 5208 - 06	6 cm depth
PS-AS 5208 - 07	7 cm depth
PS-AS 5208 - 08	8 cm depth
PS-AS 5208 - 09	9 cm depth
PS-AS 5208 - 10	10 cm depth

Extra Deep



Toothed Blades

PS-AS 5210 - 03	3 cm depth
PS-AS 5210 - 04	4 cm depth
PS-AS 5210 - 05	5 cm depth
PS-AS 5210 - 06	6 cm depth
PS-AS 5210 - 08	7 cm depth
PS-AS 5210 - 03	8 cm depth
PS-AS 5210 - 09	9 cm depth
PS-AS 5210 - 10	10 cm depth
PS-AS 5210 - 12	11 cm depth

Extra Deep



Wide Muscle Blades - Teeth

Extra Deep

27mm width	
PS-AS 5204 - 03	3 cm depth
PS-AS 5204 - 04	4 cm depth
PS-AS 5204 - 05	5 cm depth
PS-AS 5204 - 06	6 cm depth
PS-AS 5204 - 08	7 cm depth
PS-AS 5204 - 03	8 cm depth
PS-AS 5204 - 09	9 cm depth
PS-AS 5204 - 10	10 cm depth
PS-AS 5204 - 12	11 cm depth



Narrow Muscle Blades - Teeth

Extra Deep

20mm width	
PS-AS 5206 - 03	3 cm depth
PS-AS 5206 - 04	4 cm depth
PS-AS 5206 - 05	5 cm depth
PS-AS 5206 - 06	6 cm depth
PS-AS 5206 - 08	7 cm depth
PS-AS 5206 - 03	8 cm depth
PS-AS 5206 - 09	9 cm depth
PS-AS 5206 - 10	10 cm depth
PS-AS 2506 - 12	11 cm depth



Thin Muscle Blades - 2 Teeth

17 mm width	
PS-AS 5207 - 03	3 cm depth
PS-AS 5207 - 04	4 cm depth
PS-AS 5207 - 05	5 cm depth
PS-AS 5207 - 06	6 cm depth
PS-AS 5207 - 07	7 cm depth
PS-AS 5207 - 08	8 cm depth

Surgicals & Instruments

MICRO DISCECTOMY INSTRUMENT SET

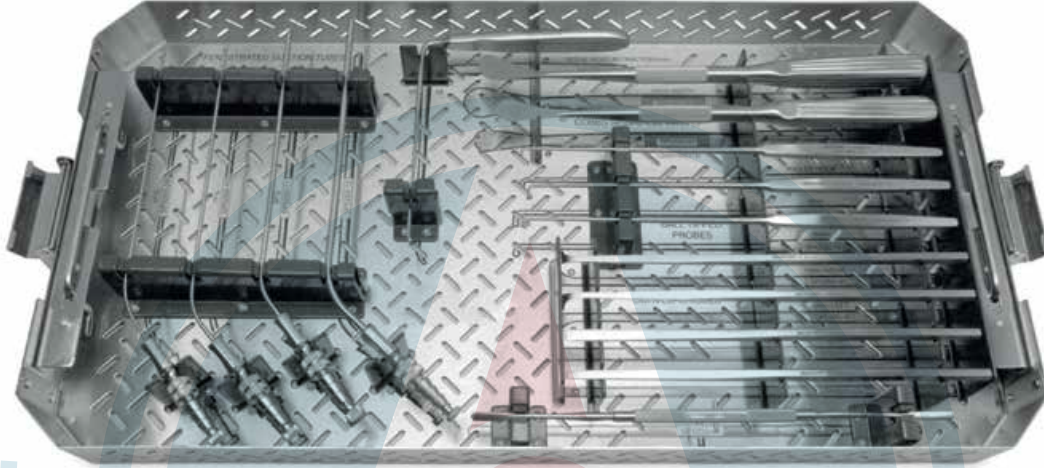

McCulloch Style Instrument Set with Container

Complete set consisting of:

PS-AS 5200 - 05

Qty	Order Code	Description
1	PS-AS 5250 - 15	McCulloch Spinal Hook, 4mm tip - 23cm/9" length
1	PS-AS 5250 - 13	McCulloch Spinal Probe, 4mm tip - 23cm/9" length
1	PS-AS 5250 - 14	McCulloch Spinal Probe, 6mm tip - 23cm/9" length
1	PS-AS 5250 - 07	Cobbs Spinal Elevator, 12mm width - 26cm/10 1/4" length
1	PS-AS 5250 - 08	Cobbs Spinal Elevator, 19mm width - 26cm/10 1/4" length
1	PS-AS 5250 - 03	Spinal Osteotome, 4mm width - 22cm/8 1/2" length
1	PS-AS 5250 - 04	Spinal Osteotome, 6mm width - 22cm/8 1/2" length
1	PS-AS 5250 - 05	'Hockey Stick' Chisel, 5mm width - 22cm/8 1/2" length, curved right
1	PS-AS 5250 - 06	'Hockey Stick' Chisel, 5mm width - 22cm/8 1/2" length, curved left
1	PS-AS 5250 - 01	Elevator Double Ended, 24cm/9 3/4" length
1	PS-AS 5250 - 01	McCulloch Suction Tube, Fenestrated tip, 23cm/9" length, 6FG, 2.0mm Ø
1	PS-AS 5250 - 10	McCulloch Suction Tube, Fenestrated tip, 23cm/9" length, 7FG, 2.3mm Ø
1	PS-AS 5250 - 11	McCulloch Suction Tube, Fenestrated tip, 23cm/9" length, 9FG, 3.0mm Ø
1	PS-AS 5250 - 12	McCulloch Suction Tube, Fenestrated tip, 23cm/9" length, 12FG, 4.0mm Ø
1	PS-AS 5250 - 02	McCulloch Nerve Root Retractor, 90 angled, 6mm tip, 12.5cm/5" working length

McCulloch Style Spinal Hook/Probe

- 23cm/9" length
Hook
Tip 4mm

PS-AS 5250 - 15



- Probe Ball
Tip 4mm

PS-AS 5250 - 13



- Probe Ball
Tip 6mm

PS-AS 5250 - 14



Surgicals & Instruments

MICRO DISCECTOMY SET

Cobbs Spinal Elevator

- 26cm/10 ¼" length

Width

PS-AS 250 - 07 12 mm

PS-AS 250 - 07 12 mm



Cobbs Spinal Elevator

- 26cm/10 ¼" length

Width

PS-AS 250 - 07 12 mm

PS-AS 250 - 07 12 mm



Cobbs Spinal Elevator

- 26cm/10 ¼" length

Width

PS-AS 250 - 07 12 mm

PS-AS 250 - 07 12 mm



Cobbs Spinal Elevator

- 26cm/10 ¼" length

Width

PS-AS 250 - 07 12 mm

PS-AS 250 - 07 12 mm



Cobbs Spinal Elevator

- 26cm/10 ¼" length

Width

Width

PS-AS 5250 - 09 6FG 2.0mm Ø

PS-AS 5250 - 10 7FG 2.3mm Ø

PS-AS 5250 - 11 9FG 3.0mm Ø

PS-AS 5250 - 12 12FG 4.0mm Ø



McCulloch Nerve Root Retractor

- 90 Angled
- 6mm tip
- 12.5cm/5" working length

PS-AS 5250 - 02



Surgicals & Instruments

'BLACK BELT' ADVANCED CERVICAL RETRACTOR SET

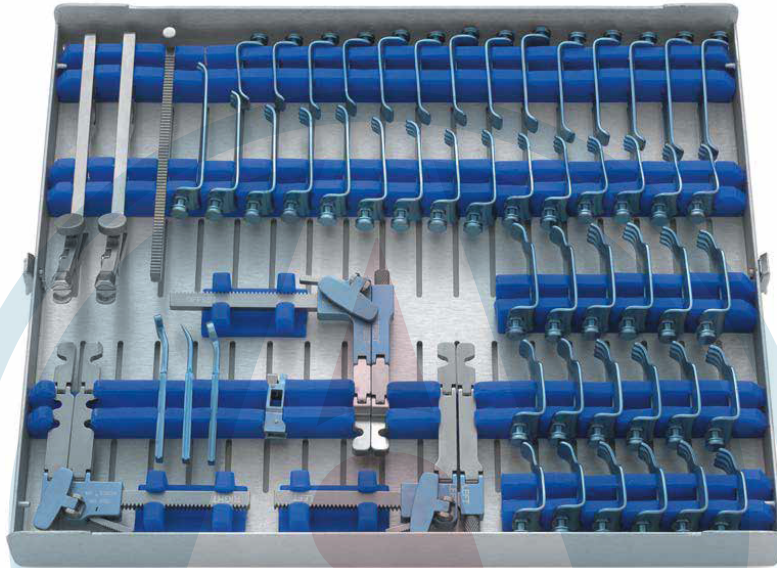

*Titanium Blade Set Illustrated

An advanced Cervical retractor system suitable for both Anterior and Posterior Cervical Surgery but with attachments for Micro Discectomy Surgery.

Basic 'Black Belt' Cervical Retractor System

Complete set consisting of: **AS 7320 - 00**

Qty	Order Code	Description
1	AS 7320 -10	Retractor Frame RIGHT
1	AS 7320 -20	Retractor Frame LEFT
1	AS 7320 -30	Retractor Frame OFFSET
2	AS 7320 -40	Blade Insertion Clamps
14	AS 7322 - 34/70	Pronged Blades 34mm - 70mm
14	AS 324 - 34/70	Blunt Blades 34mm - 70mm
12	AS 7326 - 40/55	Two Level Pronged Blades 40mm - 55mm
6	AS 7328- 40/55	Two Level Blunt Blades 40mm - 55mm
1	AS 7320 - 50	Container

Extended 'Black Belt' Cervical Retractor System

Consisting of: **AS 5200 - 05**

Standard 'Black Belt' Retractor with the addition of Micro Discectomy Attachments as detailed on page 56

Coloured Titanium 'Black Belt' Cervical Retractor System

Complete set consisting of: **AS 7320 -00M**

Qty	Order Code	Description
1	AS 7320 -10M	Retractor Frame RIGHT
1	AS 7320 -20M	Retractor Frame LEFT
1	AS 7320 -30M	Retractor Frame OFFSET
2	AS 7320 -40M	Blade Insertion Clamps
14	AS 7322 - 34/7M	Pronged Blades 34mm - 70mm
14	AS 324 - 34/70M	Blunt Blades 34mm - 70mm
12	AS 7326 - 40/55 M	Two Level Pronged Blades 40mm - 55mm
6	AS 7328- 40/M55M	Two Level Blunt Blades 40mm - 55mm
1	AS 7320 - 50M	Container

Coloured Titanium Extended 'Black Belt' Cervical Retractor System

Consisting of: **AS 7320 - 05M**

Standard 'Black Belt' Retractor with the addition of Micro Discectomy Attachments as detailed on page 56

Surgicals & Instruments

'BLACK BELT' ADVANCED CERVICAL RETRACTOR SET

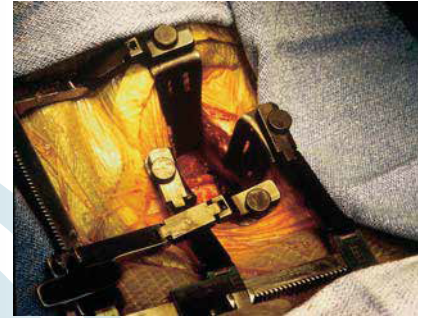

- Full jointed retractor arms
- Black non-glare finish
- Wide blade range
- Suitable for single or multi level retraction

Blades

- The blade shape is designed to resist climbing out of the surgical site
- The wider two level blades have an extra bend near the tip which follows the contour of the vertebrae or visualising



27mm wide two level Pronged blade
 27mm wide two level blade
 22mm wide Pronged blade
 22mm wide Blunt blade
 17mm wide optional narrow Cervical blades 40mm to 60mm depth

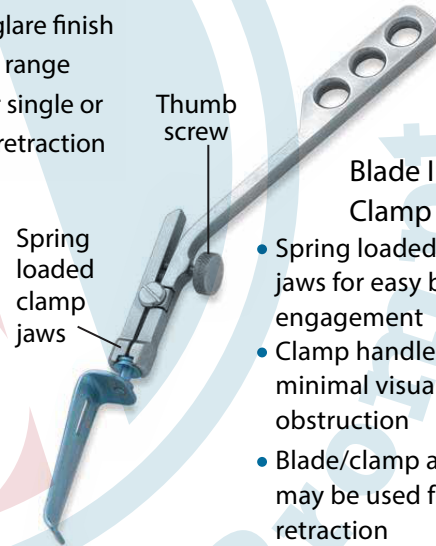

Blade Inserter Clamp

- Spring loaded clamping jaws for easy blade engagement
- Clamp handles create minimal visual obstruction
- Blade/clamp assembly may be used for hand retraction
- Clamps are quickly/easily removed after retractor arms have securely engaged the blades

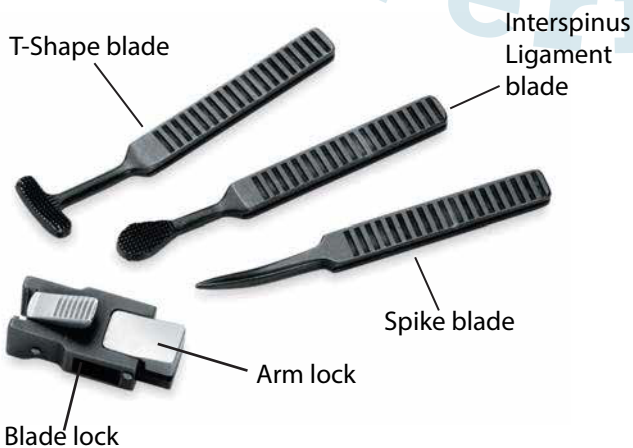

Lumbar Micro Discectomy Attachments

With this set the standard Cervical Retractor becomes a Lumbar Microdiscectomy Retractor unit.

AS 7321 - 00

Complete set consisting of:

Qty	Order Code	Description
1	AS 7321 -10	Micro Disc attachment
1	AS 7321 - 20	Spike Blade
1	AS 7321 - 30	T-Shape Blade
1	AS 7321 - 40	Inner Spine Ligament Blade
1	AS 7321- 85	Pronged Blade 85mm depth

Surgicals & Instruments

SUPER-SLIDE II LAMINECTOMY RETRACTOR SET

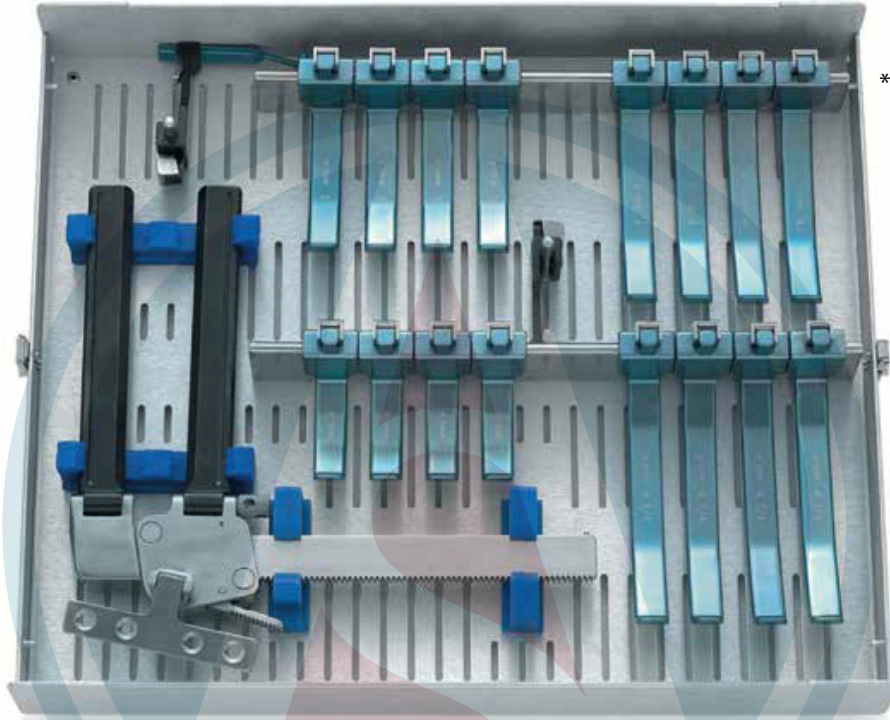

*Titanium Blade Set Illustrated

A powerful retractor with a selection of blade depths which can be positioned anywhere along the retractor arms. Allows excellent exposure of the spine in Pedicle Screw and Laminectomy procedures.

Super-Slide Retractor Basic Set

Complete set consisting of: AS 7329 - 00

Qty	Order Code	Description
1	AS 7329 - 10	Retractor Frame
4	AS 7329 - 20	Small blades 2" deep
4	AS 7329 - 30	Medium blades 3" deep
4	AS 7329 - 40	Large blades 4" deep
1	AS 7329 - 50	Instrument container

Super-Slide Retractor Extended Set

AS 7329 - 00 Includes components of basic set plus:

Qty	Order Code	Description
4	AS 7329 - 47	Supplementary blades 4 3/4" deep
2	AS 7329 - 60	Unilateral blade heads
2	AS 7329 - 62	Unilateral T-blades

Titanium Super-Slide Retractor Basic Set

Complete set consisting of: AS 7329 - 06

Qty	Order Code	Description
1	AS 7329 - 10	Retractor Frame
4	AS 7329 - 82	Small Titanium blades 2" deep
4	AS 7329 - 84	Medium Titanium blades 3" deep
4	AS 7329 - 86	Large Titanium blades 4" deep
1	AS 7329 - 90	Instrument container

Titanium Super-Slide Retractor Extended Set

AS 7329 - 09 Includes components of Titanium basic set plus:

Qty	Order Code	Description
4	AS 7329 - 47	Supplementary Titanium blades 4 3/4" deep
2	AS 7329 - 60	Unilateral blade heads
2	AS 7329 - 62	Unilateral Titanium T-blades

Surgicals & Instruments

SUPER-SLIDE II LAMINECTOMY RETRACTOR SET

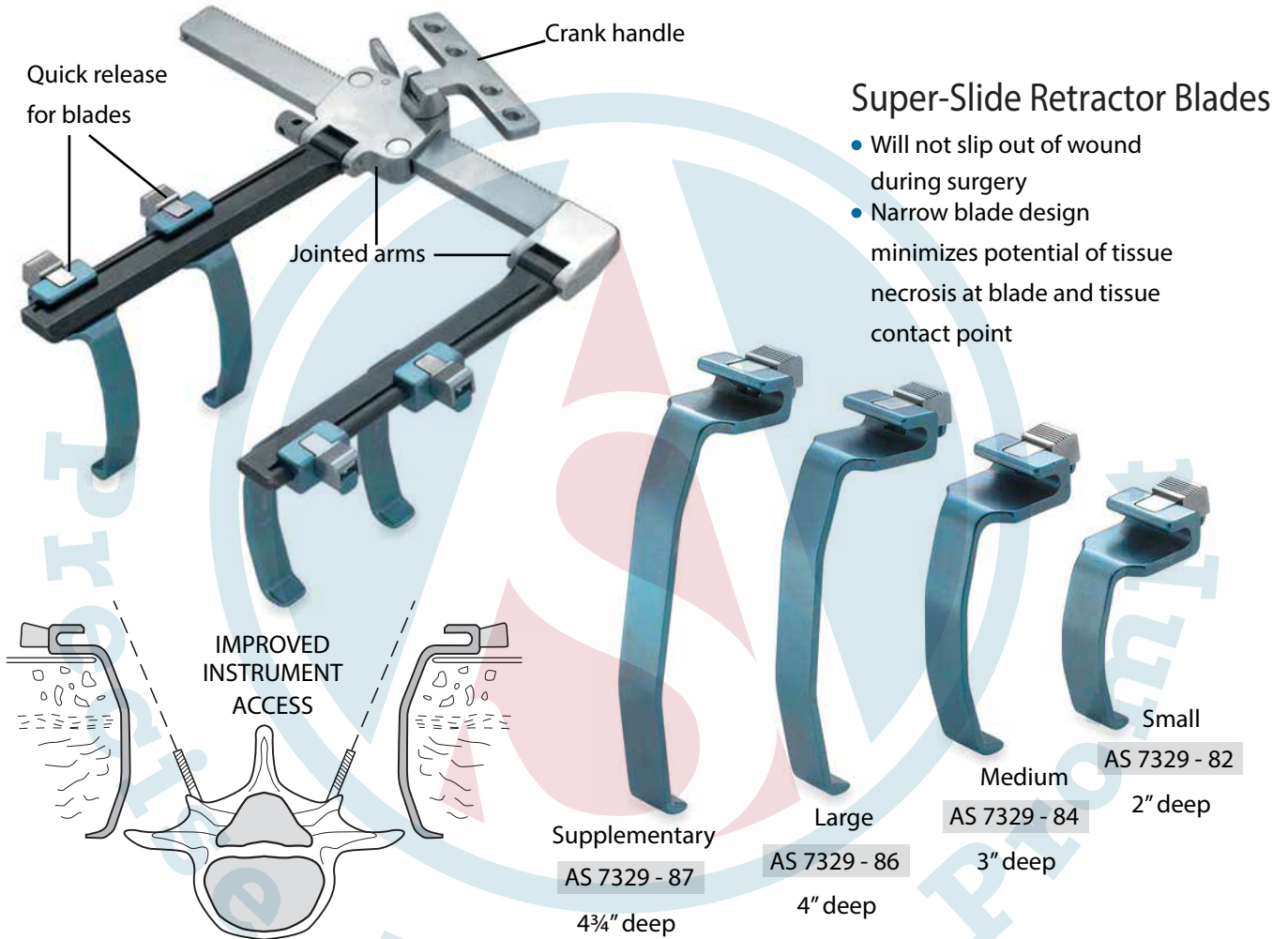

Super-Slide Retractor Blades

- Will not slip out of wound during surgery
- Narrow blade design minimizes potential of tissue necrosis at blade and tissue contact point

Unilateral Blade Attachment

- Blades lock into any chosen position along the retractor arms and may be changed at any time during surgery
- Arm locks allow the surgeon the choice of either attaching to the retractor arms then placing the unit into the wound or placing the blades into the wound then engaging the frame arms
- To obtain a unilateral exposure, use the unilateral blade attachments contained in the extended set. The T-Blade is designed to attain a firm purchase on the Spinous process
- The T-Blade can be adjusted to the correct depth with the blade lock

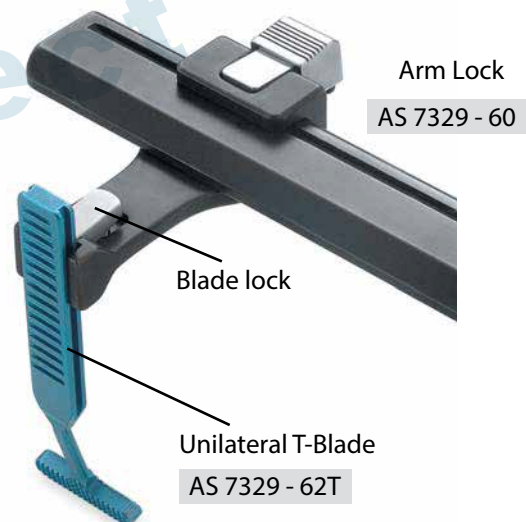

Surgicals & Instruments

CASPAR MICRO LUMBAR DISCECTOMY RETRACTOR

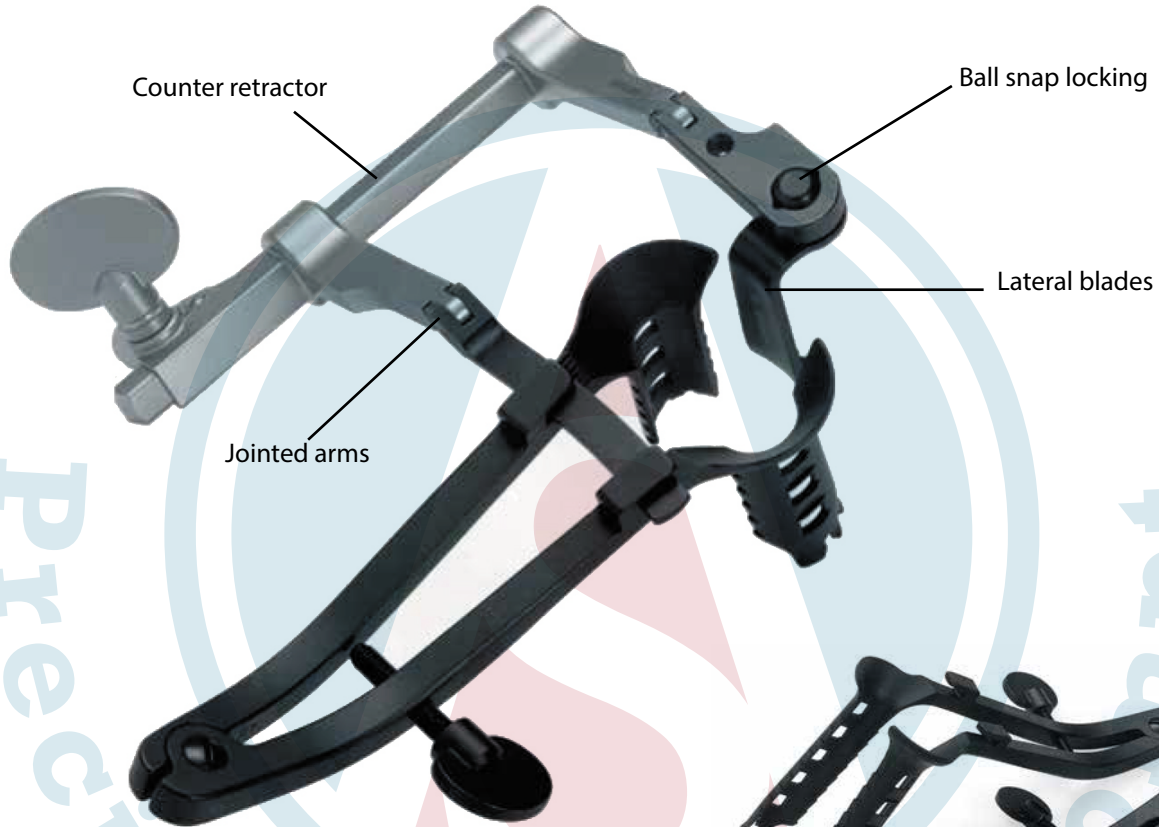

Caspar Micro Discectomy Retractor

- This Retractor Set allows a micro surgery approach to Lumbar Disc
- Specula have a black surface finish to prevent glare
- Fenestrated blades on the specula reduce the risk of movement during surgery

Complete Set

SP AS 5100- 00

Consisting of:

Lateral Blades	Depth	Specula	Depth
PS AS 5101- 40	40mm	PS AS 5100- 40	40mm
PS AS 5101- 45	40mm	PS AS 5100- 45	45mm
PS AS 5101- 50	40mm	PS AS 5100- 50	50mm
PS AS 5101- 55	40mm	PS AS 5100- 55	55mm
PS AS 5101- 60	40mm	PS AS 5100- 60	60mm
PS AS 5101- 65	40mm	PS AS 5100- 65	65mm
PS AS 5101- 70	40mm	PS AS 5100- 70	70mm

SP AS 5102- 00 Counter Retractor Frame

SP AS 5103- 00 Blade Ejector Forceps

Surgicals & Instruments

CASPAR MICRO LUMBAR DISCECTOMY RETRACTOR

Lateral Blades



Blade Ejector Forceps

PS AS 5103- 00



Specula Range



Caspar Micro Discectomy

Retractor Frame

PS AS 5102- 00



Surgicals & Instruments

BLACK BELT MICRO DISCECTOMY RETRACTOR SET



Black Belt Micro Discectomy Retractor Set

A specialist retractor for Lumbar Micro Discectomy Surgery featuring:

- Jointed retractor arms
- Adjustable blade depth
- Range of pronged blades
- Powerful ratchet action with quick release mechanism

AS 7276 - 00 Complete set

Complete set consisting of:

Qty	Order Code	Description
1	AS 7276 -10	Retractor Frame
1	AS 7276 -15	Blade Inserting Clamp
1	AS 7276 -20	Spike Blade
1	AS 7276 -30	T-Shape Blade
1	AS 7276 -35	Inner Spine - Ligament Blade
1	AS 7276 -40	Pronged Blade 40mm
1	AS 7276 -45	Pronged Blade 45mm
1	AS 7276 -50	Pronged Blade 50mm
1	AS 7276 -60	Pronged Blade 60mm
1	AS 7276 -70	Pronged Blade 70mm
1	AS 7276 -85	Pronged Blade 85mm
1	AS 7276 -90	Sterilising Container

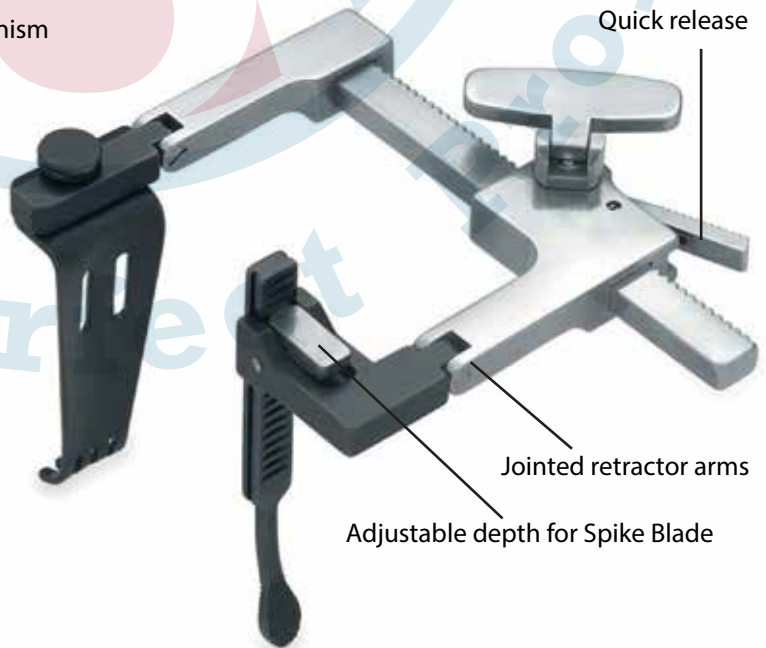

Surgicals & Instruments

BAYONET MICRO INSTRUMENTS FOR DURAL REPAIRS

Yasargil Bayonet Micro Needle Holder

- Flat Handled
- Delicate 1mm Jaws



With Lock	Straight	Curved
23cm/9"	MV-AS 1012 - 23	MV-AS1013 - 23

Without Lock	Straight	Curved
23cm/9"	MV-AS1112 - 23	MV-AS1112 - 23

Bayonet Micro Needle Holder

- Round Bodied
- Delicate 1mm Jaws



With Lock	Straight	Curved
21cm/8 1/4"	MV-AS1010 - 21	MV-AS1011 - 21
23cm/9"	MV-AS1010 - 23	MV-AS1011 - 21

Without Lock	Straight	Curved
21cm/8 1/4"	MV-AS1010 - 21	MV-AS1011 - 21
23cm/9"	MV-AS1010 - 23	MV-AS1011 - 21

Yasargil Bayonet Micro Forceps

- Flat Handled
- Blunt 1mm Tips



21cm/8 1/4"	MV-AS1010 - 21
23cm/9"	MV-AS1010 - 23

Yasargil Bayonet Micro Scissors

- Flat Handled
- 22.5cm/8 3/4" length



Standard Blade



Straight
PS-AS 3005 - 22

Vannas Blade



Straight
PS-AS 3007 - 22



Curved
PS-AS 3006 - 22



Curved
PS-AS 3008 - 22

Surgicals & Instruments

BIPOLAR FORCEPS

Straight Bipolar Forceps

- 10.5cm/4 1/4" length
- Delicate 1mm Jaws

Tip Size

0.7mm	AS -70 02 38
1mm	AS -70 02 43
Blunt	AS -70 02 41



Straight Bipolar Forceps

- 16.5cm/6 1/2" length

Tip Size

0.7mm	AS -70 01 52
1mm	AS -70 01 51



Straight Bipolar Forceps

- 19cm/7 1/2" length

Tip Size

0.7mm	AS -70 01 72
1mm	AS -70 01 71



Bayonet Bipolar Forceps

- 19cm/7 1/2" length

Tip Size

0.7mm	AS -70 01 83
1mm	AS -70 01 81
Blunt	AS -70 01 82



Surgicals & Instruments

BIPOLAR FORCEPS

Bayonet Bipolar Forceps

- 23cm/9" length



Tip Size

0.3mm	AS -70 01 90
0.7mm	AS -70 01 91
1.2mm	AS -70 01 92

Bayonet Bipolar Forceps

- 25cm/9 ½" length



Tip Size

0.3mm	AS -70 01 90
0.7mm	AS -70 01 91
1.2mm	AS -70 02 92

AS -37- 01- 35L



- Fitting Block End Forceps
- Banana Plug Vallylab Machine Fitting
- 4.5 metre length

AS -37- 01- 38L



- Fitting Block End Forceps
- Erbe BM780 Machine Fitting
- 4.5 metre length

Bayonet Bipolar Forceps SuperGliss Non-Stick Tips

- 23cm/9"



0.4mm	AS -78 01 99SG
0.7mm	AS -78 01 91SG
1.0mm	AS -78 01 98SG
1.2mm	AS -78 01 92SG



The material specially developed for SuperGliss non-stick forceps prevents overheating of the tips during coagulation. Laboratory tests confirm the outstanding non-stick properties that last throughout the lifetime of the instrument.

Surgicals & Instruments

MISC INSTRUMENTS

Slim Nose Wire Twisters

- 19cm/7 ½"

PS AS -7645 -19



Orthopaedic Locking Grips

- Hardened jaws

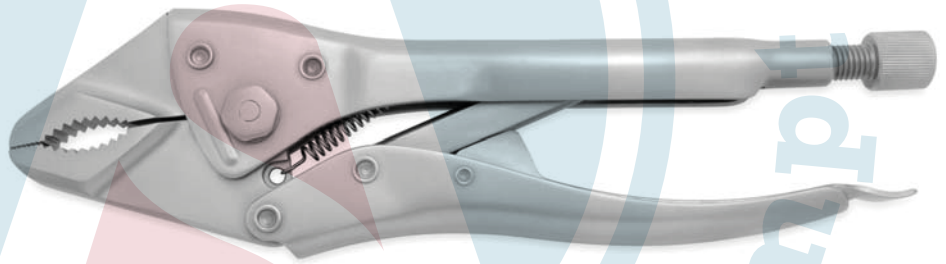

Length

AS -200-511-180	18cm/7"	Small
AS -200-511- 200	20cm/8"	Medium
AS -200-511- 240	24cm/9 ½"	Large

Combined Wire Cutter & Pliers

- 18cm/7"
- Suitable for wires up to 1.6mm

AS - 200-512-185



Surgicals & Instruments

MISC INSTRUMENTS

Bolt Cutters with dismantable arms

- Max. cap 6.3mm pins
- 57cm length

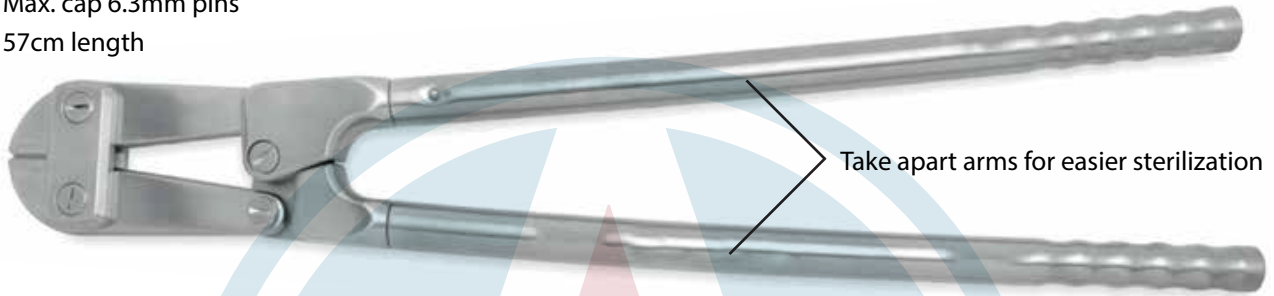

AS -200-500-585

- Must be used in conjunction with a Rod Holder.
Ordering Code: 200 - 675 - 200

Muller-Claus Wire Cutters

- Tungsten Carbide Jaws
- Tungsten Carbide Jaws

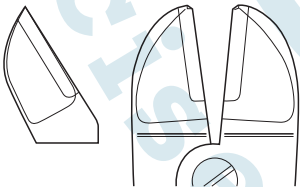

Length

AS -8 - 810E18 18cm/7" Sui

AS -8 - 800E22 22cm/8 3/4" Suitable for wires up to 3mm diameter

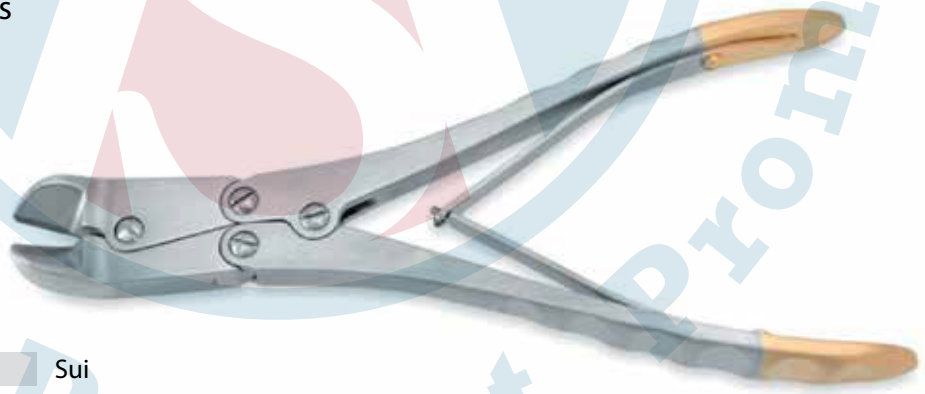

Needle Nosed Locking Pliers

- 18cm/7"
- Suitable for wires up to 1.6mm



Length

AS -200-514 - 220 22cm/8 3/4" Small

AS -200-515 - 250 25cm/9 3/4" Medium

AS -200-516 - 300 30cm/11 1/2" Large

- A very useful instrument for orthopaedic surgery allowing the surgeon to securely clamp on to wires and implants.

Surgicals & Instruments

MISC INSTRUMENTS

Measuring Caliper

- 25cm/10"

PS-AS 7334 - 20



Castroviejo Caliper

- 7cm/2¾"
- Measuring range 3mm to 25mm

PS-AS 7334 - 10

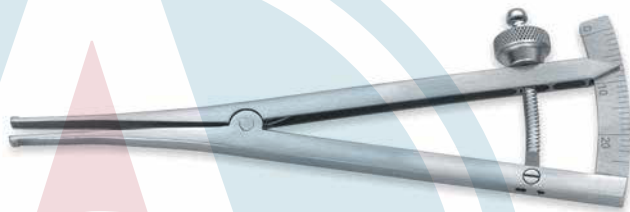

Vernier Caliper

- 22.5cm/9"
- Measuring range 15cm

PS-AS 7338 - 00

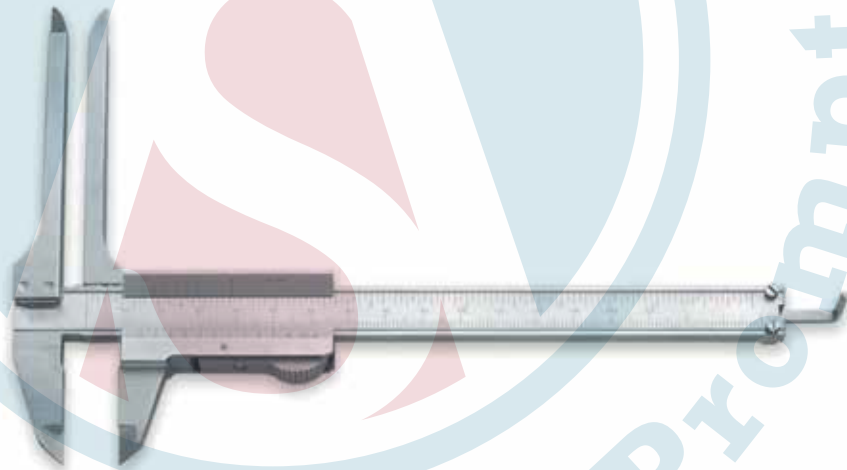

Depth Gauge

- Measuring depth up to 50mm

PS-AS 7350 - 00



Depth Gauge

- Measuring depth up to 00mm

PS-AS 7370 - 00



Direct Reading Depth Gauge

- 23cm length
- Measuring range 0.5 to 40mm

PS-AS 7333 - 00



Surgicals & Instruments

MISC INSTRUMENTS

Frazier Suction Tube

- 17cm/6 ¾"

PS-AS 9041-17	6FG	2.0mm
PS-AS 9042-17	7FG	2.3mm
PS-AS 9043-17	8FG	2.7mm
PS-AS 9044-17	9FG	3.0mm
PS-AS 9045-17	10FG	3.3mm
PS-AS 9046-17	11FG	3.7mm
PS-AS 9047-17	12FG	4.0mm



Frazier Suction Tube

- 23cm/9"

PS-AS 9041-23	6FG	2.0mm
PS-AS 9042-23	7FG	2.3mm
PS-AS 9043-23	8FG	2.7mm
PS-AS 9044-23	9FG	3.0mm
PS-AS 9045-23	10FG	3.3mm
PS-AS 9046-23	11FG	3.7mm
PS-AS 9047-23	12FG	4.0mm



Bayonet Dissecting Forceps

19cm/7 ½" Tip Size

PS-AS 9701-19	1mm
PS-AS 9702-19	2mm

21cm/8 ½" Tip Size

PS-AS 9701-21	1mm
PS-AS 9702-21	2mm





Alliance

Surgicals & Instruments

ALLIANCE SPECIAL RETRACTORS

Finochietto Spine Retractor

PS-AS 9702-01



Dr Remani Micro Dissectomy Retractor

PS-AS 9703-01





Alliance

Surgicals & Instruments

ALLIANCE SPECIAL RETRACTORS

Mayfield Skull Retractor System

PS-AS 9704-01





Alliance

Surgicals & Instruments

ALLIANCE SPECIAL RETRACTORS

Wilson Radiolusent Frame

PS-AS 9705-01



MIS Tublar Retractor System

PS-AS 9706-01

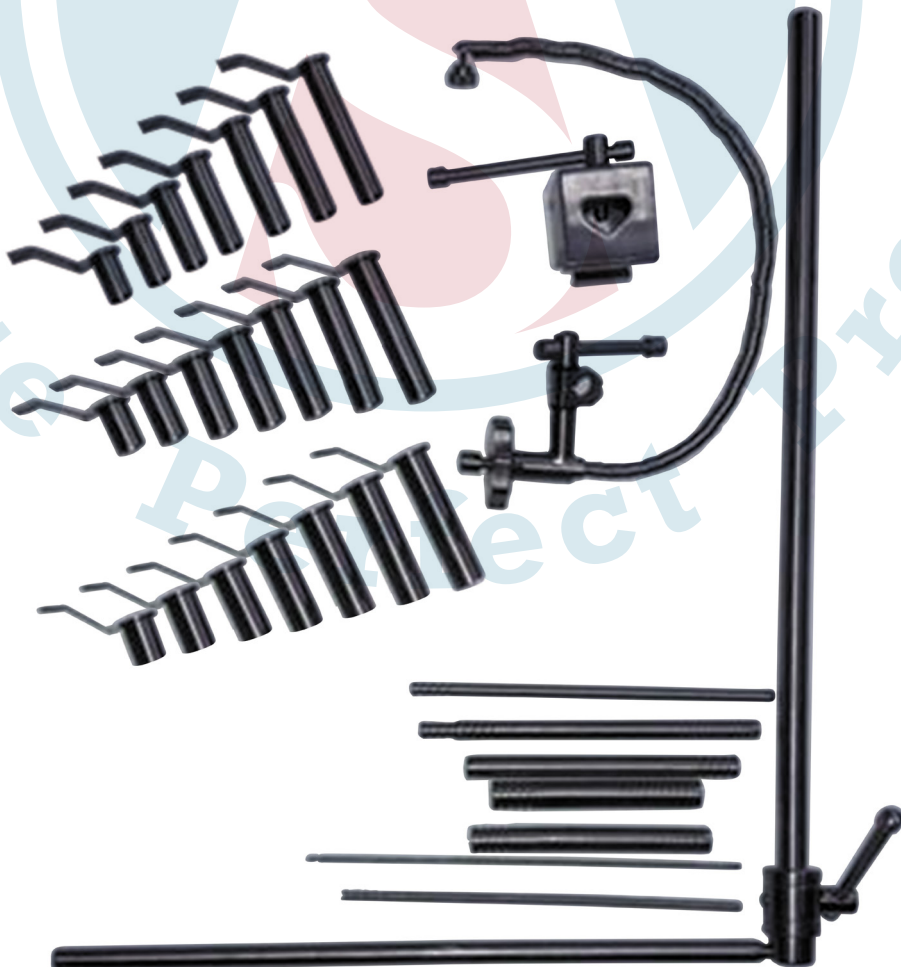



Alliance

Surgicals & Instruments

ALLIANCE SPECIAL RETRACTORS

Leyla Self Retaining Retractor System

PS-AS 9707-01

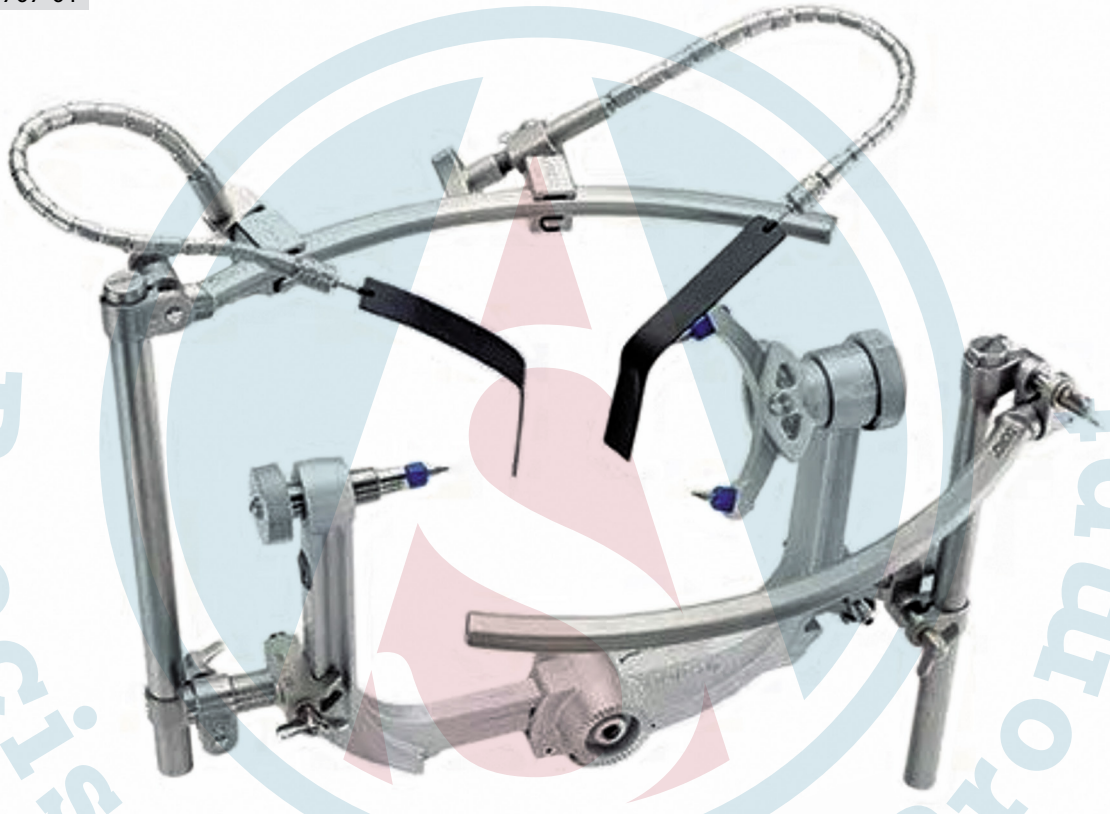



Surgicals & Instruments

Quality is Reward of Hardwork

WHO WE ARE

For the last 18 years, Alliance Surgical & Instruments customers have benefited from our outstanding industry knowledge and our ability to consistently provide high-quality specialized surgical instruments. Our Instrument Experts bring years of industrial experience to every customer interaction and fort constantly strive to meet our primary goal of -100% customer satisfaction.

Known for providing unsurpassed overall value, the instruments we sell are backed by a surgeon satisfaction guarantee. We will only provide you with a variety of quality instruments that will match your required specifications and deliver an equal- or superior-quality instrument with substantially more value and 99% of our customers report - surgeon satisfaction.

Our extensive knowledge comes from 18 years of industrial experience. And we will only provide you with a quote on instruments that match your instrumental specifications and deliver an equal or superior quality instrument with substantially more value.

Quality is Reward of HARDWORK



ANNANAD P.O, CHALAKUDY, THRISSUR, KERALA - 680309
Email: info@alliancesurgicals.com, Website: www.alliancesurgicals.com



Alliance

Surgicals & Instruments

Quality is Reward of Hardwork

CDSCO Reg No-Allian-Thris-KL/M/MD/009981



ANNANAD P.O, CHALAKUDY, THRISSUR, KERALA - 680309
Email: info@alliancesurgicals.com, Website: www.alliancesurgicals.com