



Alliance

Surgicals & Instruments

Since last 18 years



Caring for The Bones

ORTHOPAEDIC

— SPECIAL INSTRUMENTS —

ANNANAD P.O, CHALAKUDY, THRISSUR, KERALA - 680309

Email: info@alliancesurgicals.com, Website: www.alliancesurgicals.com

Phone: +91 0480 2717722 Mob: +91 9349855004

Introduction

Alliance Surgical is an established manufacture of surgical instruments. With our wide range we cover Instruments for surgeries from head to toe.

We present our catalogue detailing our range of instrument-ation for Orthopaedic Surgery.

These specialist Instruments are manufactured to the highest possible standards with the most modern processes and technology.



The
EXPERIENCE
Along **HISTORY**



9662904000065@cnrb

Damaged Screw Extractor Set



Facilitates the removal of damaged screws. Suitable for 3.5 & 4.5 screws

Screw Retrivaler



OR AS - 001

Locking Driver Set



4.5 3.5

Carbide Bits



5 4 3.5 2.5

Hollow - Mill



2.7 - OR AS - 003

3.5 - OR AS - 004

4.5 - OR AS - 005

6.5 - OR AS - 006

Bone Clamp



OR AS - 007 Forwam
OR AS - 008 Humerous
OR AS - 009 Paediatric

A great time saver in force arm/Humerus reduction. Plate inserting facility without disturbing reduction.

Alliance K Wire Cutter



OR AS - 010

K Wire Cutter with tungsten Carbide Tip for K-Wire up to 2.5 mm

K Wire Cutter



OR AS - 011

K Wire Cutter with tungsten Carbide Tip for K-Wire up to 1.5 mm

Broken Interlocking Nail Extractor



OR AS - 012

Unique thread design useful for Brocken Nails. Designed to be used in a counter clockwise direction

Interlocking Rasp

Courtesy: Dr. N.J Karne

OR AS - 013
Humerous

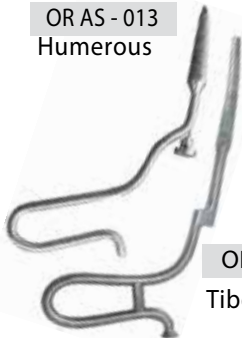

OR AS - 014
Tibea & Femur

The cannulated Rasp to widen the interlocking entry point from 8 mm to 13 mm

Implant Extractor with Slap Hammer

Large
OR AS - 015

Small
OR AS - 016



The tungsten tipped extractor for squire nails, interlocking nails, K-nails, K-wires, rush nails knowled Pins, AM pins, Screws etc.

Wire Twister with self Cutting



R AS - 017

Wire Tensioner with automatic cutting, An innovating instrument for cerclage wiring

Universal interlocking Nail Extractor



OR AS - 018

Extractor for any interlocking nails of any make

Small Bone Compressor / Distractors



OR AS - 019

Radiolucent



Fixed Arm - OR AS - 020

Rotated Arm - OR AS - 021



OR AS - 022



OR AS - 023

Dial mechanism helps allow precise control of inserted wires in small bone surgery

Hinterman Distractor



OR AS - 024

To distract small joints in a linear direction in foot, hand and spine surgery



Courtesy: Dr. Dhiraj Patil

Calcaneal Spreader



OR AS - 025

Used for lateral column lengthening of the calcaneus

Mippo Wire Passer

Courtesy: Dr. Samir J Shah, Baroda



OR AS - 026

OR AS - 026A

For large & Small Bones



Bone Mill

Table mounted with crank handle



OR AS - 027

For grinding bone chips used for bone graft procedures

Plateau elevators

Courtesy: Dr. R.M Chandak



OR AS - 320

Clearview Open Blade

Self- Retaining Retractor



OR AS - 321

Open Blade Design allows clear visualization of soft tissue and Neurovascular structures being Retracted

Offset Handle Hip

Retractor-L/R



OR AS - 322

The 90° offset handle helps move the assistant's hand out of the way, allowing better access to the surgical site.

Osteotomes

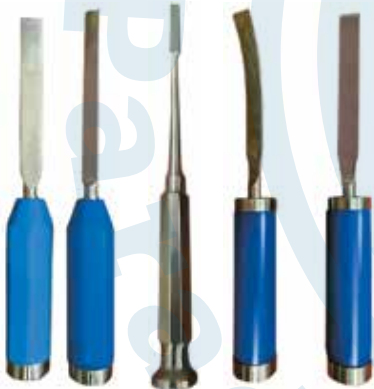

OR AS - 323A OR AS - 323B OR AS - 323B

Osteotomes with Guard

Courtesy: Dr. Arun Prakash



OR AS - 323D

Fracture Distractor

Courtesy: Dr. Sameer B Palaskar



OR AS - 324



OR AS - 325

Radioopaque Retractors & Bone Levers

Courtesy: Dr. Sunil Khemke, Raipur



OR AS - 326



OR AS - 327



OR AS - 328

Micro fracture Drill Sleeve

OR AS - 044



OR AS - 045

45° Angled

Double Barrel Femoral Guide Sleeve



OR AS - 046

Femoral Guide pin insertion
pelvic and acetabulum fixation
reverse diamond fixation

Radiolucent Sleeve



OR AS - 047

Custom design

Protecting Sleeve



OR AS - 048

13 mm ø Radiolucent

Double Barrell Drill Sleeve for Distal Femur

Save radiation sleeve



OR AS - 042

After fixing the first distal screw, you can fix
the second screw without any "C" arm exposer

Guide Wire Sterilizing Tube



OR AS - 043

Pediatric Lateral Condyle Clamp



OR AS - 049

"S" Wire Bender



OR AS - 050

Bending on 120°

Buck K-Wire Bender



OR AS - 051

Can bend K-Wires
0.5 to 1.2 mm

Durham Bone Clamp



OR AS - 052

Allow application of a bone plate
without removing the reduction
clamp on medium size bones
such as the Fibula, Ulna and Radius

Nose Pliers

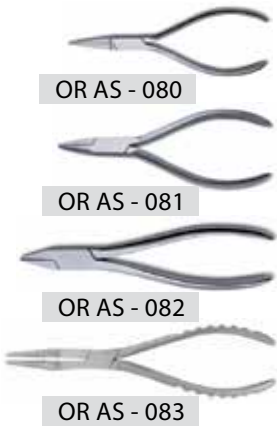

Available in Narrow nose, flat nose, long jaw needle & dolphin nose

Inter Changeable Instruments



OR AS - 084
Osteotomes, gouges impactors, curettes, Rasps with quick coupling handle

Cannulated Wire Passers

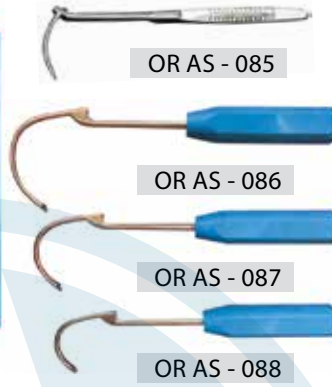

Wire passers for patella forearm humerus Femour and Tibia

Wire - Passers

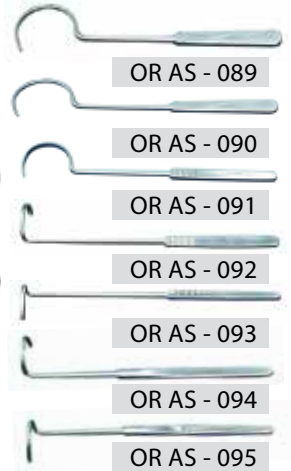

Used for Forearm, Humerus Femour & Tibiya

Suction Tube and Cautery Holder



OR AS - 079

Syndesmosis Clamp



OR AS - 097

Condyle Clamp



Large OR AS - 098

Small OR AS - 099

Condyle Clamp With Sleeve



OR AS - 100

Curette with suction



OR AS - 101

Patella Holding Forceps



Smart Lock



OR AS - 102



OR AS - 103



OR AS - 104

Available with Ratchet Lock Speed Lock and smart Lock

Two Pointed Reduction Clamp



OR AS - 105

OR AS - 106

OR AS - 107

Designed for Medical Malleolar/ Bone Fragment

Graft Holder & Impactor



OR AS - 108

Bone graft can be grasped & placed

Fibula Holder

Courtesy: Dr. Sajith Babu



OR AS - 028

Steinmann Pin Introducer T-Handle

Universal Chuck w/o Key
(Fully stainless steel)



Fixed Arm - OR AS - 029

Rotated Arm - OR AS - 030

Gelpi-Blade Retractor



OR AS - 031

OR AS - 032

Dial mechanism helps allow precise control of inserted wires in small bone surgery

Plate Holding Forceps

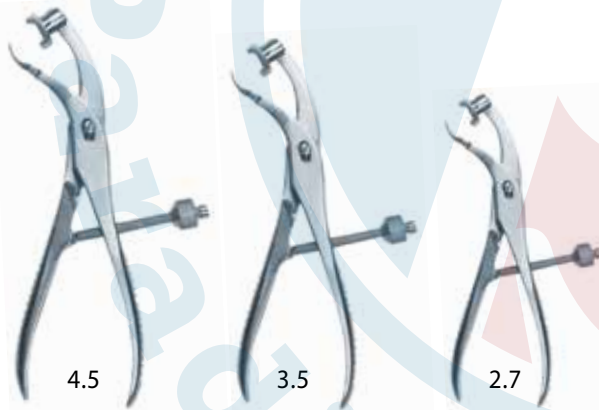

OR AS - 033

OR AS - 034

OR AS - 035

Plate Holding Forceps with Screw guide



OR AS - 036

OR AS - 037

Curette Osteotome



OR AS - 038

Easy removal of osteophytes and cartilage without having to switch tools

Dr. Shantanu's

Curette

Courtesy: Dr. Shantanu, Purnea

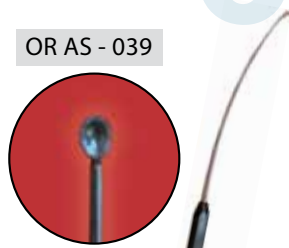

OR AS - 039

The use is mainly in Total Hip Replacement, especially while using a long femoral stem. One can feel the femoral canal and curette it nicely before cementing.

Charnley Ring

Curette

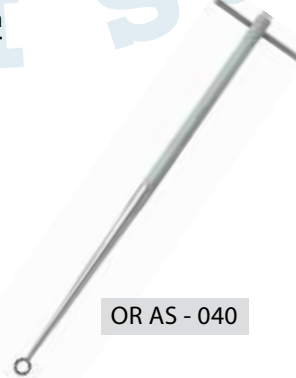

OR AS - 040

37 cm/15' Length
Double sided Serrated cutting edge T-Handle

Intramedullary

Irrigation Cannula



OR AS - 041

This cannula is very useful to give a through wash inside the intramedullary canal

Cannulated Reamer

Conical shape

Head Reamers

Rigid Reamers



OR AS - 139
Femur



OR AS - 140
Humorous



OR AS - 141
Femur



OR AS - 142
Humorous



OR AS - 143
Forearm

Capsule Scissors

Anteversion Osteotome

Pelvic Impactor

Femoral Head Extractor

Sub Trochanteric Reduction Clamp



OR AS - 144

The Angled & Curved Scissors allow a greater range of capsular access.



OR AS - 145 OR AS - 146

Used for Femoral canal preparation Available in 2 sizes.



OR AS - 147 OR AS - 148

Pointed spike for Pelvic reduction.



OR AS - 149

Self tapping cork Screw model.



OR AS - 150 L

OR AS - 151 R

Pelvic Reduction Forceps



OR AS - 152

7" Angular Short Pointed - Ball Tips



OR AS - 153

10" Angular Long Pointed - Ball Tips



OR AS - 154

10" Straight Short Pointed - Ball Tips



OR AS - 155

16" Straight Long Pointed - Ball Tips



OR AS - 156

16" Long Pointed Ball Tips 1 x 2 Jaws

Kolbel Self Retaining

Retractor with Center Blade



OR AS - 157

Center Blade
Depth 6.4 cm/2.5"

OR AS - 158
Blade - Pair
32mm x 36 mm
OR AS - 159

Subacromion Spreader

OR AS - 158



OR AS - 161

Blade - Pair
36mm x 53 mm
OR AS - 160

Used for massive tears and repair of a supraspinatus tear

Femoral Distractors



OR AS - 162

Radio Graphic Ruler



OR AS - 163

Multi purpose pliers



OR AS - 164



OR AS - 165

Plate Bending Plier



OR AS - 166



Designed for bending and cutting of K-wires and plates
Available in two sizes

Distal Screw Aiming Device



OR AS - 167

A Radiolucent device for distal Locking aiming and drilling

Plaster Cutting Guard

Courtesy: Dr. D D Tanna



Child Size
OR AS - 168

OR AS - 169

Designed to help protect the patient's skin when removing a plaster

Ortho Suction tube



OR AS - 170

Helps eliminate plugging due to bone, cement fragments blood clots etc.....

Fracture Alligner



OR AS - 171

Used to align the bone ends of a femur fracture

OR AS - 172

For lesser Trochanter

Cement Removal



OR AS - 173

OR AS - 174

OR AS - 175

Double ended instrument designed for Cement removal during arthroplasty surgery



Caspar Micro Lumbar Discectomy Retractor

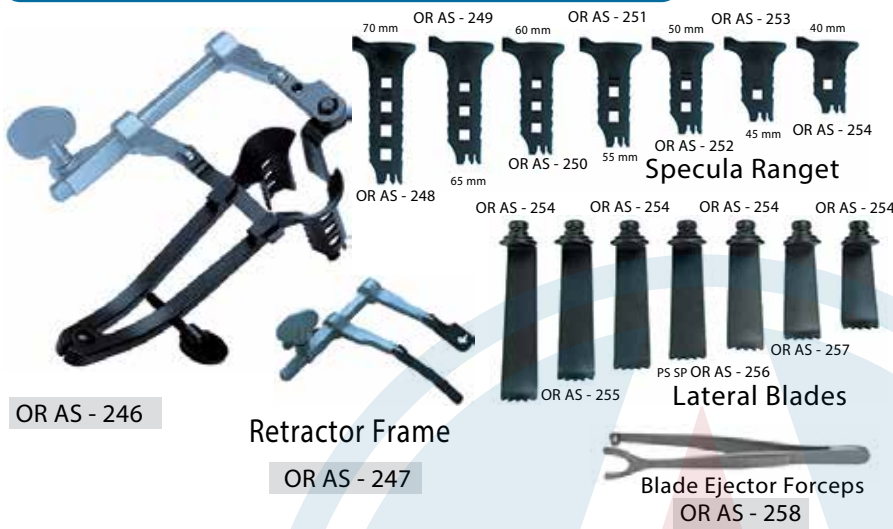

Micro Discectomy Retractor



Caspar Vertebral Body Distraction



Super -Slide Laminectomy Retractor

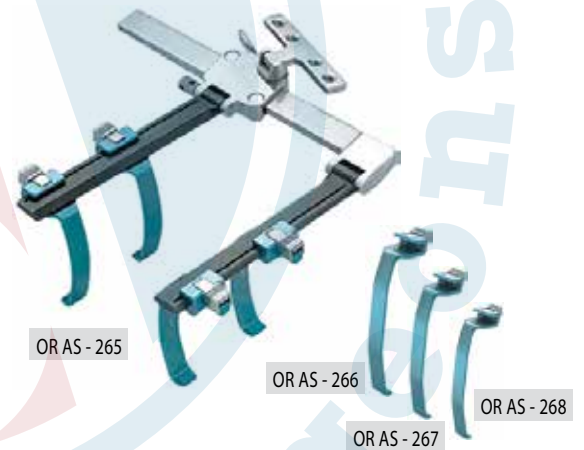

Laminectomy Retractor



Finochitto retractor with hinged arms and detachable blades.

Remani Spine Retractor Set



Casper Cervical Retractor System Titanium



Chain Retractor

Weight
.25 lb
GN 025



Crushing
OR AS - 053

Skin Hook
OR AS - 054

.25 lb
GN 035



Israel
OR AS - 055

.25 lb
GN 045



Tendon Clamp with Slit



For Cutting Tendon
and Nerve straightly

- 1mm SHF 1.0
- 1.5mm SHF 1.5
- 2mm SHF 2.0
- 2.5mm SHF 2.5
- 3mm SHF 3.0
- 3.5mm SHF 3.5
- 4mm SHF 4.0
- 5mm SHF 5.0
- 6mm SHF 6.0
- 7mm SHF 7.0

Scaphoid Lunate Clamps



OR AS - 056

OR AS - 057

Reposition Forceps
with K-Wire holder for
Percutaneous application

Reposition Forceps
for Reduction of hard
to reach Fractures

Reduction Tool

Courtesy: Dr. Amin Shah



OR AS - 058

Guide Wire Holder



OR AS - 059

Quick holding and release
of a guidewire passing through
the IM canal. Also holding
1 mm to 4 mm K-Wire

Asymetric Webers Clamp

Straight, Curved, Reduction Forceps



OR AS - 060



OR AS - 061



OR AS - 062



OR AS - 063

Make a 2.5 mm hole in the shaft to accommodate the straight tip of the Forceps
curved tip will engage tip of Olecranon to allow placement of the plate
while holding reduction. Also used medial malleolus fractures.

Femoral Tibial Spreader



OR AS - 064

Alliance Reduction Clamp

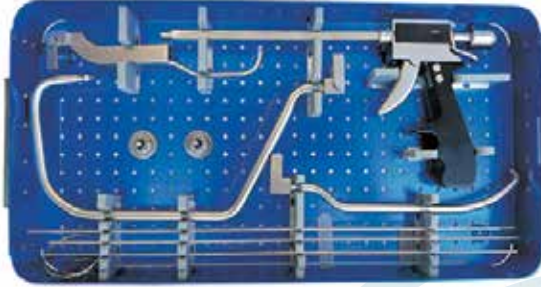

OR AS - 065

A Minimally invasive reduction

Soft Impact Handles



Designed to have shock-absorbed force, providing less bounce or wasted force. Used for Osteotomes Gouges and Mallets

Double - Ended Hohman Bone leavers

OR AS - 068

OR AS - 067



OR AS - 066

OR AS - 069

Cannulated Bone Awl

OR AS - 070



Raindrop K-wire Holder

OR AS - 071



A Chuckless K-Wire holder for 0.5 to 2.5mm K-wires

Open Reduction Forceps

OR AS - 072



The clamp allows accurate insertion of pins for internal fixation

Special Shoulder Surgery Set



OR AS - 073

With two pairs of blade



OR AS - 073-A



OR AS - 073-B

Bonw Awl 5"



- Humrus Str. AHS -002
- Humrus Cvd. AHS -003
- Fore Arm Str. AHS -004
- Fore Arm Cvd. AHS -005
- Finger Str. AHS -006

Straight & Curved

Blade Retractors



- 15 X 5 mm AHS -007
- 20 X 5 mm AHS -008
- 15 X 8 mm AHS -009
- 20 X 8 mm AHS -010

Mini Langenbeck 5"
Mini Sen muller 5"
Available in any dimensions

Sharp Hook



AHS -012

To Check Fracture
and remove
Ingrown tissue

Bone Rasp



AHS -013

Bone Scoop



- 2mm AHS -014
- 4mm AHS -015

Caroll Osteotome



- 2 mm AHS -016
- 4 mm AHS -017
- 6 mm AHS -018
- 8 mm AHS -019
- 9 mm AHS -020
- 10 mm AHS -021
- 12 mm AHS -022
- 14 mm AHS -023
- 16 mm AHS -024

Bone Graft impactor



- 2 mm AHS -025
- 4 mm AHS -026

Available in round
and Rectangular
shapes

Periosteal Elevator



- 2 mm Str. AHS -027
- 5mm Str. AHS -028
- 3 mm Cvd. AHS -029
- 5 mm Cvd. AHS -030

Available in round
and Rectangular
shapes

**Tendon
Aproximator**



AHS -031

**Tendon
Stripper 12" & 6"**

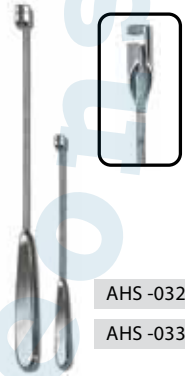

- AHS -032
- AHS -033

Available in 2 sizes

Special Hand Surgery Instruments

Courtesy: Dr. Sudhir Warriar



AHS - 001

A Radiolucent Forceps for
Closed reduction



AHS -037



AHS -037



AHS -037



AHS -037



AHS -038



**Lumbar & Cervical
Curette**



OR AS - 272 OR AS - 273

**Bone Marrow
Aspiration Needles**



OR AS - 274 OR AS - 275

Needle with depth stop and trocar. Available in two sizes.

**Bone Biospy Needles
with Trocar and Ejector**

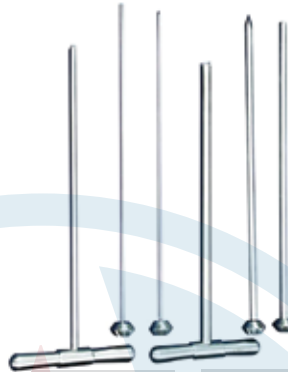

OR AS - 276 OR AS - 277

Available in two sizes 3 mm and 8 mm.

Bionet Cervical Curette



8 1/2" 9 1/2"

Cup Size	OR AS - 290 -40 CL
0000	OR AS - 290 -40 CL
000	OR AS - 290 -40 CL
00	OR AS - 290 -40 CL
0	OR AS - 290 -40 CL

Kerrison Laminectomy Rongeurs

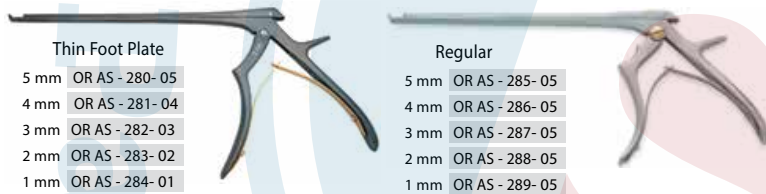

Thin Foot Plate

5 mm	OR AS - 280-05
4 mm	OR AS - 281-04
3 mm	OR AS - 282-03
2 mm	OR AS - 283-02
1 mm	OR AS - 284-01

Regular

5 mm	OR AS - 285-05
4 mm	OR AS - 286-05
3 mm	OR AS - 287-05
2 mm	OR AS - 288-05
1 mm	OR AS - 289-05

**Bone Graft
Funnel**



5mm 8mm
OR AS - 278 OR AS - 279

5 & 8mm bore funnel with piston can be used to pack bone graft in hard to reach places in a minimally invasive method.

Foramenotomy Punch



Black Plasma Coated, thin Foot Plate, detachable with ejector

Ferris-smith Kerrison Punch



Long Anterior Kerrission Punch

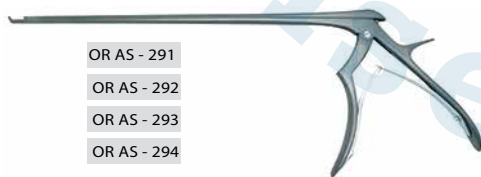

OR AS - 291
OR AS - 292
OR AS - 293
OR AS - 294

Intervertebral Disc Rongeur



Straight
OR AS - 299-18
OR AS - 300-18
OR AS - 301-18
OR AS - 302-18

Kerrison Punch Down



OR AS - 295
OR AS - 296
OR AS - 297
OR AS - 298



Upward
OR AS - 303-18
OR AS - 303-18
OR AS - 303-18
OR AS - 303-18

Intervertebral Disc Rongeur Black



OR AS - 304 B
OR AS - 305 B
OR AS - 306 B
OR AS - 307 B



Downward
OR AS - 308-18
OR AS - 308-18
OR AS - 308-18
OR AS - 308-18

Silver Knife with Sterilizing Box



OR AS - 309

Humby Skin Grafting Handle with Sterilizing Box



OR AS - 310

Casper Cervical Retractor System Ordinary



OR AS - 312

Cervical Pin Retractor Set



OR AS - 314

Endzone Retractor



OR AS - 315

Designed for use when placing the end Screws while plating a fracture using a minimally invasive technique

Casper Cervical Retractor System Titanium



OR AS - 316

Interchangeable Osteotome Set

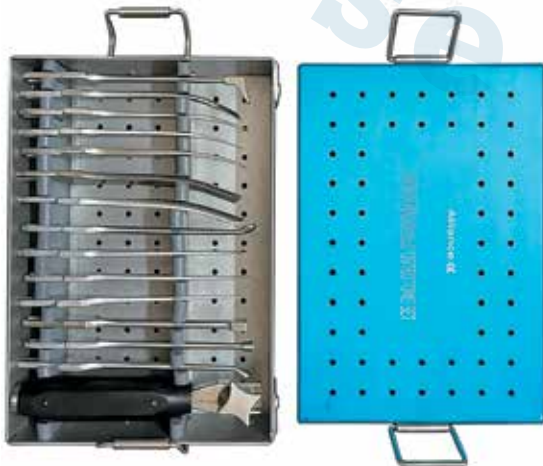

OR AS - 317



OR AS - 318

Designed to align an incision during closing

Remani Spine Retractor Set



OR AS - 319

Pelvic Reduction Forceps



OR AS - 109

OR AS - 110

16" Long pointed Ball Tips

13" Reduction Forceps with Screws.

Cement Grasping Forceps



OR AS - 111

OR AS - 112

Cement Removal Instruments



Overall Length 13"

Femoral Head Bone Plug Cutter



OR AS - 113

Taking Bone from femoral head to plug femoral canal before cementing

Flexible Osteotomes

7" OR AS - 114 7" OR AS - 116 7" OR AS - 118 7" OR AS - 120
9" OR AS - 115 9" OR AS - 117 9" OR AS - 119 9" OR AS - 121



Sharp, Flexible blades are well suited for loosening implants from cement or bony in growth fixation.

Ball Reamers



The extra long Ball reamers may be used to ream cement layers as well as cement islands in the distal femoral cavity

Micro Forceps



6" Round Body Plain & Toothed

6" Flat Body Plain & Toothed

Castro Viejo Needle Holder Scissors



STR OR AS - 127 OR AS - 129
CVD OR AS - 128 OR AS - 130

6" Straight & Curved

Charnley Retractor



OR AS - 074

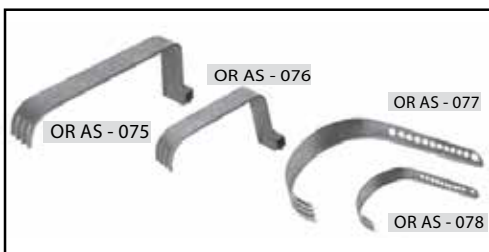

With two Pairs of blade

Osteophytes Osteotome



OR AS - 134

20 cm



25 cm

30 cm



OR AS - 137

Mippo Tunnelers

Wire Holder



OR AS - 138

HIP Retractors with Grip handle

HIP Skid

Overall Length 300 mm
Blade Width 29 mm

OR AS - 237



Cobra Retractor

Overall Length 340 mm
Blade Width 30 mm

OR AS - 238



Pelvis Retractor

Overall Length 340 mm
Blade Width 30 mm

OR AS - 239



Double Bend Hohmann Retractor

Overall Length 300 mm
Blade Width 29 mm

OR AS - 240



Bend Hohmann Retractor 90°

Overall Length 340 mm
Blade Width 19 mm

OR AS - 241



AVA Retractor

Overall Length 370 mm
Blade Width 19 mm

OR AS - 242



Radiolucent Bone Levers



Modified Hohmann

Overall Length 260 mm
Blade Width 22 mm

OR AS - 243



Standard Hohmann

Overall Length 260 mm
Blade Width 22 mm

OR AS - 244



Humeral Retractor

Overall Length 210 mm
Blade Width 25 mm

OR AS - 245

Sinha Radiolucent

Demersal



OR AS - 237

Designed to retract and protect the femur while preparing the acetabulum for reaming during anterolateral approach total hip surgery.

Rular with 45° Angle Handle

Useful for measuring distances in small deep incisions.

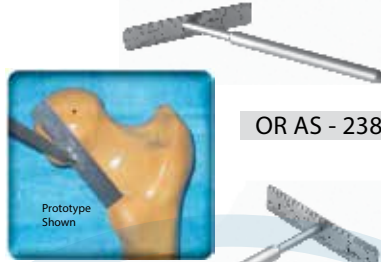

OR AS - 238

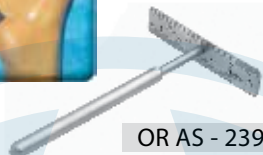

OR AS - 239

Rular with Right Angle Handle

Useful for measure the femoral head/neck length.

Mazzara Rongeur

with Pistol Grip Handle



OR AS - 240

Pistol Grip handle lessens hand fatigue and slippage, and allows for better visualization

Mongold Capsule Knife

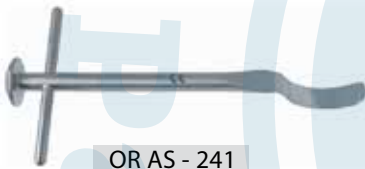

OR AS - 241

Designed to reach behind the femoral head to release the capsule Alignment.



OR AS - 242

Designed for retracting tissue away from the bone

Femoral Extraction Instruments

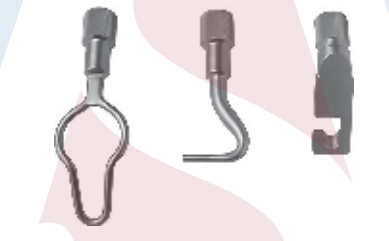

OR AS - 243

Designed to help in the removal of various types of femoral Implants.

Bargo Femoral Lift

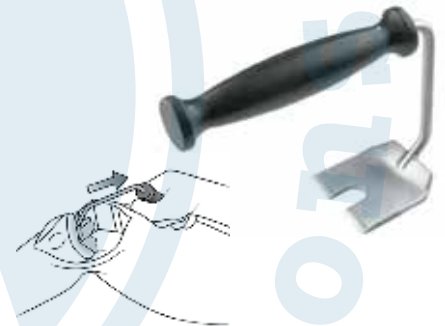

OR AS - 244

Designed to distract the distal femur up and away from the proximal tibia during TKR to help expose the popliteal fossa and access the soft tissues for meniscal excision

Browne Deltoid Retractor



OR AS - 245

Used for the Delto-Pectoral/Approach

Duncan Metatarsal Clamp



OR AS - 246

Designed to clamp and hold osteotomy metatarsal bones in the correct position for function through the clamps top opening.

O'Brien Bone Clamps



OR AS - 246

Designed for use in stabilization of a fracture or osteotomy in small bone surgery

Knee Self Retaining Retractors

Curved Hohmann, Narrow
OR AS - 176

Curved Hohmann, Wide
OR AS - 177

PCL Retractor
OR AS - 178

Retractors

Pattella Retractor
OR AS - 179

Collateral Ligament Retractor Single Tip
OR AS - 180

Collateral Ligament Retractor Double Tip
OR AS - 181

Anterior Femoral Condylar Retractor

OR AS - 182

Collateral Ligament Retractor

OR AS - 183

Helps protect the lateral collateral ligament while exposing the proximal tibia

45° Knee Retractors

OR SP3108 - 01

OR AS - 184

OR AS - 185

Designed for general use around the knee

S" Total Knee Retractor

OR AS - 186

Helps to protect the collateral ligaments and popliteal structures while providing excellent Visualization within the knee joint.

Z Knee Retractor

OR AS - 187

Helps create better access to the articulating surfaces

Posterior Capsule and Sciatic Nerve Protection Retractors



Right : OR AS - 188 R

Left : OR AS - 189 L

Sits on the outer rim of the posterior/ischium to retract the posterior capsule for acetabular exposure and help to the sciatic nerve.

Hip Bone Levers

OR AS - 190

OR AS - 191

OR AS - 192

OR AS - 193

OR AS - 194

OR AS - 195

OR AS - 196

OR AS - 197

OR AS - 198

OR AS - 199

MIH Retractors



Overall Length 330 mm
Blade Width 25 mm

OR AS - 200

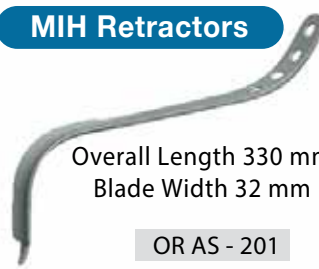

Overall Length 330 mm
Blade Width 32 mm

OR AS - 201



Overall Length 330 mm
Blade Width 40 mm

OR AS - 202



Deep Hohman

Overall Length 330 mm
Blade Width 25 mm

OR AS - 203

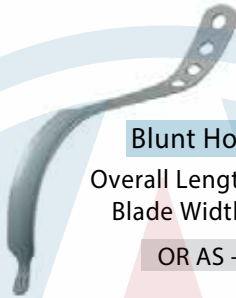

Blunt Hohman

Overall Length 330 mm
Blade Width 32 mm

OR AS - 204



Muller Hohman

Overall Length 350 mm
Blade Width 40 mm

OR AS - 205

HIP Retractors



40° Angled
Overall Length 280 mm
Blade Width 18 mm

OR AS - 206

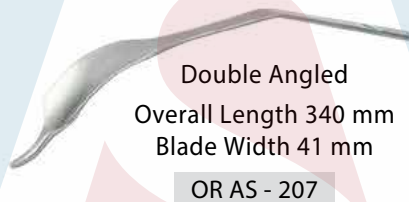

Double Angled
Overall Length 340 mm
Blade Width 41 mm

OR AS - 207

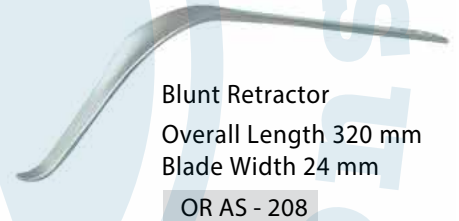

Blunt Retractor
Overall Length 320 mm
Blade Width 24 mm

OR AS - 208

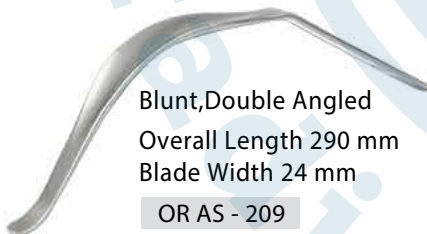

Blunt, Double Angled
Overall Length 290 mm
Blade Width 24 mm

OR AS - 209



Bone, lever after Ganz
Overall Length 270 mm
Blade Width 24 mm

OR AS - 210

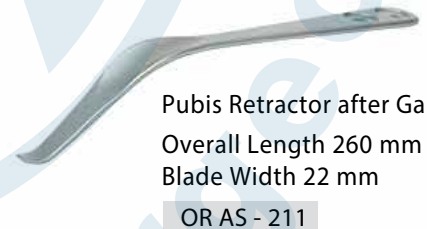

Pubis Retractor after Ganz
Overall Length 260 mm
Blade Width 22 mm

OR AS - 211



Double Bend Hohmann
Overall Length 280 mm
Blade Width 15 mm

OR AS - 212



Double Bend Hohmann
Overall Length 310 mm
Blade Width 22 mm

OR AS - 213

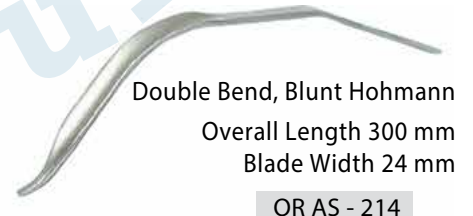

Double Bend, Blunt Hohmann
Overall Length 300 mm
Blade Width 24 mm

OR AS - 214



Bone lever Amin Wide
Overall Length 320 mm
Blade Width 32 mm

OR AS - 215

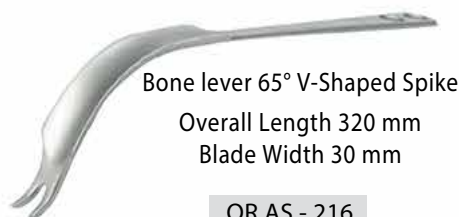

Bone lever 65° V-Shaped Spike
Overall Length 320 mm
Blade Width 30 mm

OR AS - 216



Trochant Bone Lever
V-Shaped Long Spike
Overall Length 330 mm
Blade Width 30 mm

OR AS - 217

HIP Retractors



Double Bend 2 Prongs Hohmann
Overall Length 330 mm
Blade Width 25 mm

OR AS - 218

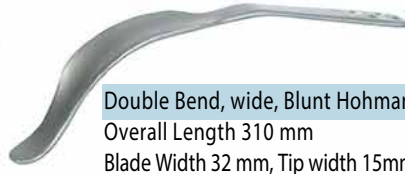

Double Bend, wide, Blunt Hohmann
Overall Length 310 mm
Blade Width 32 mm, Tip width 15mm

OR AS - 219



Blunt Hohmann
Overall Length 280 mm
Blade Width 32 mm,
Tip width 15mm

OR AS - 220



Neck Elevator, Muller
Overall Length 380 mm
Blade Width 26 mm

OR AS - 221



90° Angled Deep Retractor
Overall Length 210 mm
Blade Width 12 mm

OR AS - 222

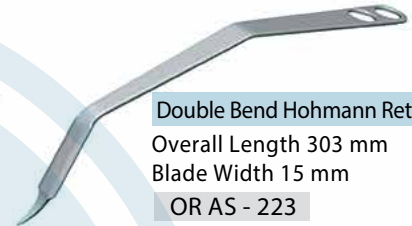

Double Bend Hohmann Retractor
Overall Length 303 mm
Blade Width 15 mm

OR AS - 223



Pelvis Retractor
Overall Length 310 mm
Blade Width 22 mm

OR AS - 224

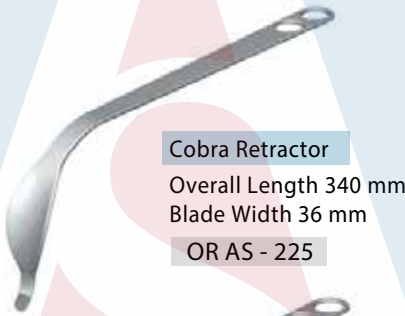

Cobra Retractor
Overall Length 340 mm
Blade Width 36 mm

OR AS - 225



Cobra Retractor
Overall Length 340 mm
Blade Width 30 mm

OR AS - 226

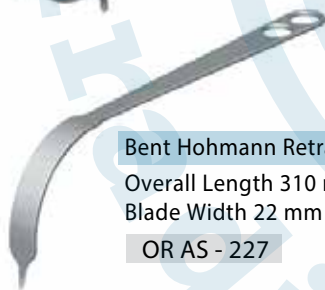

Bent Hohmann Retractor
Overall Length 310 mm
Blade Width 22 mm

OR AS - 227

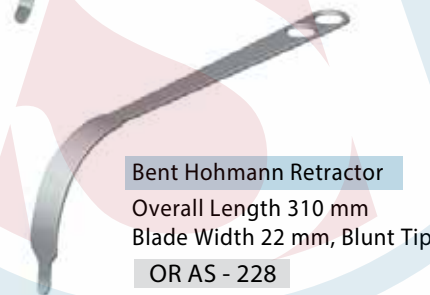

Bent Hohmann Retractor
Overall Length 310 mm
Blade Width 22 mm, Blunt Tip

OR AS - 228

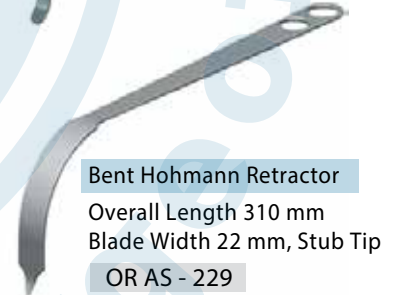

Bent Hohmann Retractor
Overall Length 310 mm
Blade Width 22 mm, Stub Tip

OR AS - 229

Bent Hohmann Retractor 90°

Overall Length 250 mm
Blade Width 19 mm
OR AS - 230



Bent Hohmann Retractor 90°
Overall Length 185 mm
Blade Width 19 mm

OR AS - 231



AVA Retractor
Overall Length 285 mm
Blade Width 22 mm Blunt Tip

OR AS - 232



AVA Retractor
Overall Length 285 mm
Blade Width 22 mm

OR AS - 233

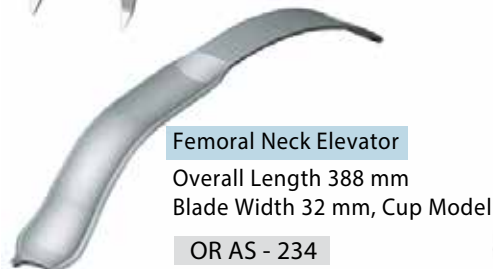

Femoral Neck Elevator
Overall Length 388 mm
Blade Width 32 mm, Cup Model

OR AS - 234



Femoral Neck Elevator
Overall Length 325 mm
Blade Width 25 mm

OR AS - 235



Femoral Neck Elevator
Overall Length 332 mm
Blade Width 25 mm

OR AS - 236

*Quality is Reward of **HARDWORK***

WHO WE ARE

Since last 18 years, Alliance Surgical & Instruments customers have benefited from our outstanding industry knowledge and our ability to consistently provide high-quality specialty surgical instruments. Our Instrument Specialists bring years of industry experience to every customer interaction and constantly strive to meet our goal of 100% customer satisfaction.

Known for providing unsurpassed overall value, the instruments we sell are backed by a surgeon satisfaction guarantee. We will only provide you variety of quality instruments that will match your required specifications and deliver an equal- or superior-quality instrument with substantially more value and 99% of our customers report surgeon satisfaction.

Our extensive knowledge comes from 18 years of industry experience. And we will only provide you with a quote on instruments that match your instrument specifications and deliver an equal or superior quality instrument with substantially more value.



Our Other Products :

*Cardiac Surgery • Endoscopic Surgery • Gynecology Surgery • General Surgery
Hand Surgery • Micro Surgery • Plastic Surgery
Angioplasty Surgery • Spine Surgery*



Alliance

Surgicals & Instruments



ANNANAD P.O, CHALAKUDY, THRISSUR, KERALA - 680309
Email: info@alliancesurgical.com, Website: www.alliancesurgical.com
Phone: +91 0480 2717722 Mob: +91 9349855004