



**Alliance**

**Surgicals & Instruments**

*Quality is Reward of Hardwork*

*Since last 18 years*

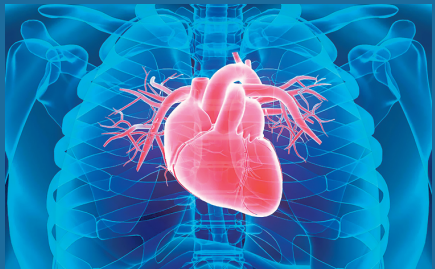
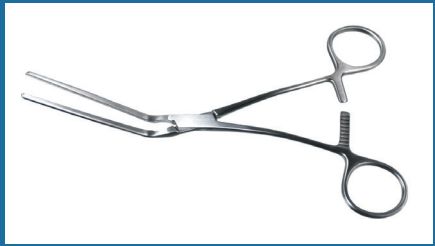
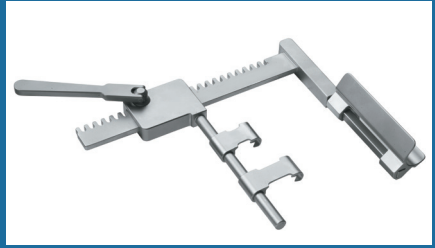

*Caring for The Heart*

# CARDIAC & VASCULAR INSTRUMENTS



**CDSO Reg No-Allian-Thris-KL/M/MD/009981**

ANNANAD P.O, CHALAKUDY THRISSUR, KERALA - 680309  
Email: [info@alliancesurgical.com](mailto:info@alliancesurgical.com) Website: [www.alliancesurgical.com](http://www.alliancesurgical.com)  
Ph.+91 0480 2717722 Mob +919349855004



# Alliance

## Surgicals & Instruments

Quality is Reward of Hardwork

### Introduction

Alliance Surgical is an established manufacturer of surgical instruments. With our vast range, we cover instruments for surgeries from head to toe.

We present our catalog detailing a range of instrumentation for Orthopaedic Surgery.

These specialist Instruments are manufactured to the highest possible standards with the most modern processes and technology.

**IRCLASS**  
SYSTEMS AND SOLUTIONS PRIVATE LIMITED  
**CERTIFICATE OF APPROVAL**  
Issued by Indian Register Quality Systems  
(A Division of IRCLASS Systems and Solutions Private Limited)

This is to certify that the Quality Management Systems of

Organisation: Alliance Surgicals and Instruments  
Address: Annanad P.O, Chalakudy Thrissur 680309 Kerala, India

has been assessed and found conforming to the following requirement

Standard: ISO 9001:2015

Scope: Production, Sales and Export of Hand Made Stainless Steel Surgical Instruments

Certificate No.: IRQS/200100770  
Initial Certification Date : 01/12/2020  
Current Date of Granting : 01/12/2020  
Expiry Date : 30/11/2023

Shashi Nath Mishra  
Head IRQS

Indian Register Quality Systems  
IRQS  
GRI 018

Head Office: 52A, Adi Shankaracharya Marg, Opp. Powell Lake, Powai, Mumbai - 400 072, India.

**IRCLASS**  
SYSTEMS AND SOLUTIONS PRIVATE LIMITED  
**CERTIFICATE OF APPROVAL**  
Issued by Indian Register Quality Systems  
(A Division of IRCLASS Systems and Solutions Private Limited)

This is to certify that the Medical Devices - Quality Management Systems of

Organisation: Alliance Surgicals and Instruments  
Address: P.O, Annanadu, Chalakudy, Thrissur - 680309

has been assessed and found conforming to the following requirement

Standard: ISO 13485:2016

Scope: Manufacture, Supply, Repair, Trade Exports of Hand-held Surgical Instruments used during surgery to clamp, cut, dissect, retract or otherwise manipulate and/or modify biological tissue or bone (scissors, Forceps, Retractors, Speculums, Ringaugers, Distotoms, Gouges, Mallets)

Certificate No.: IRQS/220760595  
Initial Certification Date : 07/06/2022  
Current Date of Granting : 07/06/2022  
Expiry Date : 06/06/2025

Shashi Nath Mishra  
Head IRQS

Head Office: 52A, Adi Shankaracharya Marg, Opp Powell Lake, Powai, Mumbai - 400 072, India.



9662904000065@cnr

**CERTIFICATE**

This is to Certify that the Products  
Non-Stainless Steel Surgical Instruments  
Manufactured by

**ALLIANCE SURGICALS & INSTRUMENTS**  
ANNANAD P.O, CHALAKUDY, THRISSUR,  
KERALA-680309, INDIA

has been independently assessed and is compliant with the requirements of

Medical Device directive (93/42/EEC)

CE

Certificate No: IN8611U  
Date of Initial registration: 03 September 2017  
Date of this Certificate: 08 August 2022  
Recertification Due: 04 September 2025

Head Office: 52A, Adi Shankaracharya Marg, Opp Powell Lake, Powai, Mumbai - 400 072, India.

Director

GONet

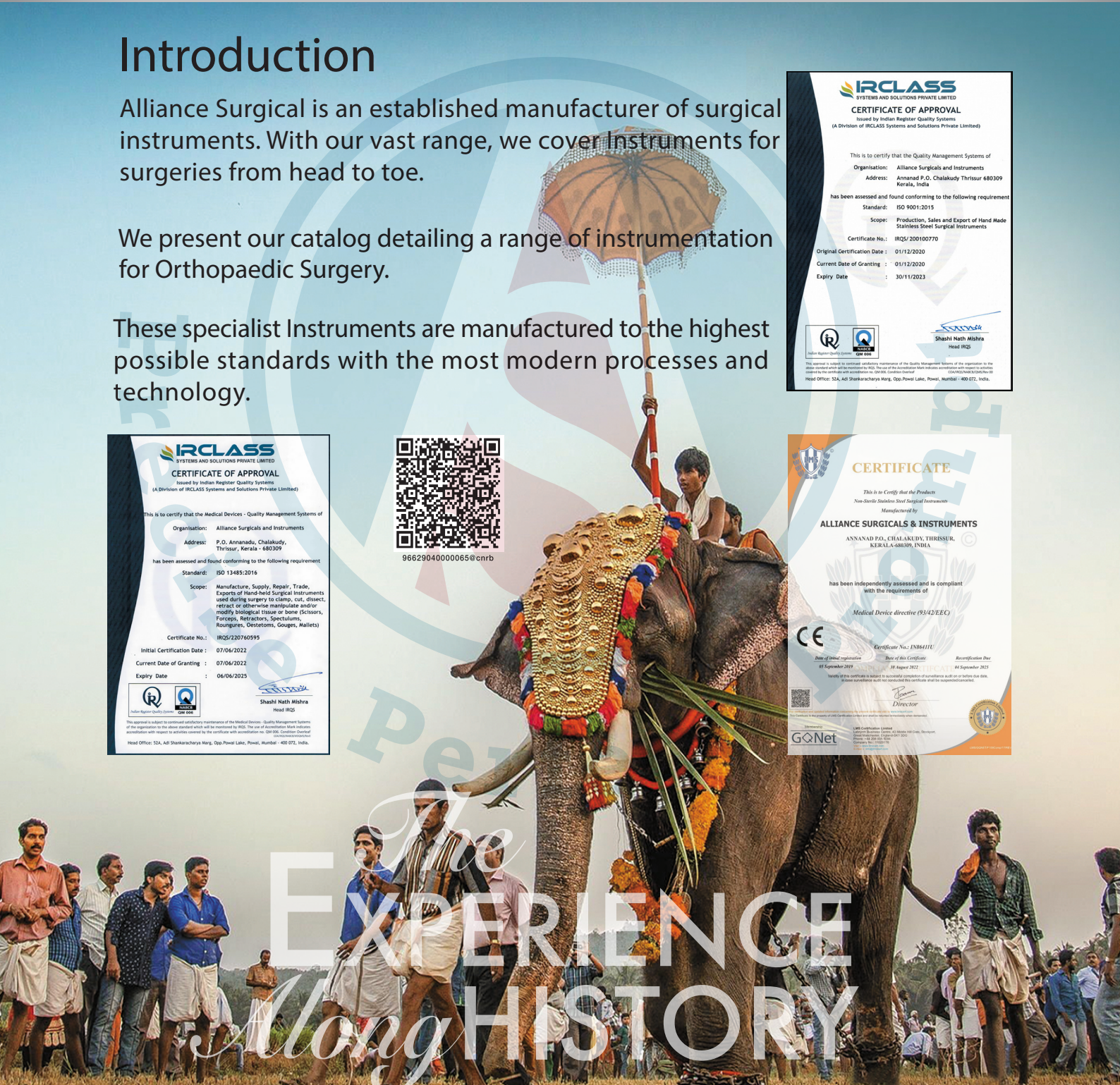

# The EXPERIENCE Along HISTORY



## Surgicals & Instruments

Quality is Reward of Hardwork

	Page No.	INDEX	Page No.
<b>NEEDLE HOLDERS</b>			
Micro Needle Holders	1,2 & 3	Titanium Mini Glover Bulldog Clamps	52 & 53
Bayonet Micro Needle Holders	4	Glover Bulldog Clamps	54
Ring handled Needle Holders	5, 6, 7 & 8	Debakey-satinsky Bulldog Clamps	54
		Debakey-carotid Bulldog Clamps	54
		Gregory 'Soft' Carotid Bulldog Clamps	55
		Modified Gregory 'Soft' Bulldog Clamps	55
		Debakey Bulldog Clamps	56
		Titanium Debakey Bulldog Clamps	57
		Bayonet Micro Instruments For Dural Repairs	58
<b>FORCEPS</b>		<b>MISC INSTRUMENTS</b>	
Vascular Forceps	9, 10 & 11	Slim Nose Wire Twisters	59
Round Bodied Micro Forceps	12 & 13	Bolt Cutters With Dismantable Arms	60
Micro Bayonet Forceps	14	Measuring Caliper	61
Bipolar Forceps	15, 16 & 17	Frazier Suction Tube	62
Bipolar Forceps	18 & 19		
		<b>VASCULAR CLAMPS</b>	
<b>SCISSORS</b>		Debakey Peripheral Clamp	63
Bipolar Scissors	20	Debakey Multi-purpose Clamp	64 & 65
Iris Scissors	21	Debakey-beck Paediatric Aortic Forceps	65
Strabismus Scissors	21	Debakey Tangential Occlusion Clamp	66
Tenotomy Scissors	22	Debakey Anastomosis Clamp	67
Jameson Scissors	22	Debakey-semb Ligature Carrier	68
Metzenbaum Scissors	23	Cooley-derra Anastomosis Clamp	69
xMayo Easy-cut Scissors	24	Javid Carotid Clamp	70
Dietrich, Coronary, Vascular Scissors	25, 26 & 27	<b>SUCTION TUBES &amp; CANNULA</b>	
Bayonet Micro Scissors	27	American Pattern Suction Tube	71
Castroviejo Micro Scissors	28	Tibbs Arterial Cannula	72
Micro Coronary Scissors	28, 29, 30	Perfusion Cannula	73
Micro Scissors	31 & 32		
		<b>VESSEL DILATORS &amp; PROBES</b>	
<b>RETRACTORS</b>		Ross Coronary Artery Probe	74
Rib Spreaders	33, 34 & 35	<b>STERILISATION CONTAINERS</b>	
Rib Spreaders	36 & 37	Single-try Containers	75
Abdominal Ring Retractor	38	Double Try Containers	75
Hooks	39 & 40	<b>MISCELLANEOUS</b>	
Retractor	40, 41, 42, 43	Rummel Cardiac Stiletto	76
Rib Cutters	44		
Rib Cutters	45	<b>ATTACHMENTS</b>	
Wire Cutters	46	Thompson Retractor System	77
Dissectors & Micro Hooks & Micro Cutters	47	Bookwalter Retractor	78
		Nathanson Liver Retractor	79
<b>BULLDOG CLAMPS</b>			
Acland Micro Clamps	48		
Disposable Vessel Clamps	49		
Dietrich Mini Bulldog Clamps	50		
Debakey-dietrich Mini Bulldog Clamps	51		



## Surgicals & Instruments

Quality is Reward of Hardwork

### MICRO NEEDLE HOLDERS

#### Reil Micro Needle Holder

- Round Bodied
- Diamond Dusted Jaws
- Delicate 1 mm Jaws

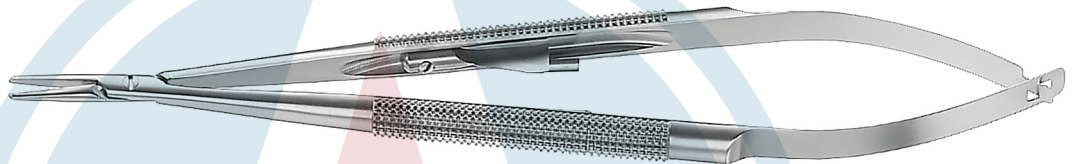

With Lock	Straight	Curved	Without Lock	Straight	Curved
14.5cm/5 1/4"	MV AS 1005-14	MV AS 1006-14	14.5cm/5 1/4"	MV AS 1105-14	MV AS 1106-14

#### Jacobson Micro Needle Holder

- Round Bodied
- Diamond Dusted Jaws
- Straight Delicate 1 mm Jaws

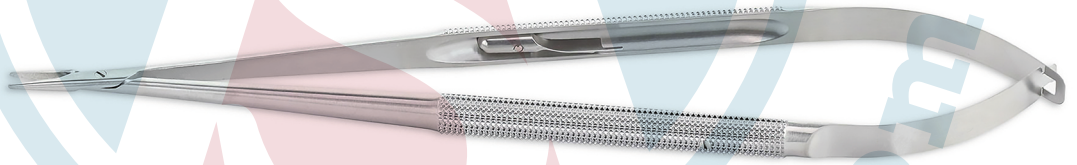

With Lock		Without Lock	
18cm/7"	MV AS 1005-18	18cm/7"	MV AS 1105-18
21cm/8 1/4"	MV AS 1005-21	21cm/8 1/4"	MV AS 1105-21
23cm/9"	MV AS 1005-23	23cm/7"	MV AS 1105-23

#### Titanium Jacobson Micro Needle Holder

- Round Bodied
- Diamond Dusted Jaws
- Straight

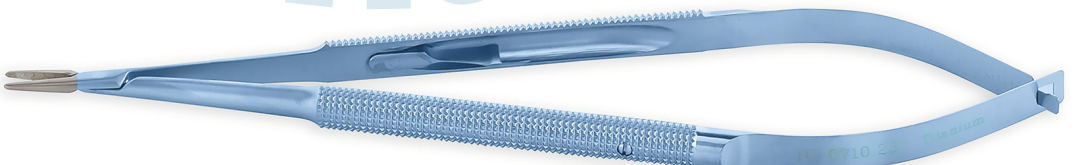

With Lock	Standard 12mm Jaws	Delicate 1mm Jaws	Without Lock	Standard 12mm Jaws	Delicate 1mm Jaws
15 cm/6"	CV AS 1005-15T	CV AS 1005-15FT	15 cm/6"	CV AS 1105-15T	CV AS 1105-15FT
18 cm/7"	CV AS 1005-18T	CV AS 1005-18FT	18 cm/7"	CV AS 1105-18T	CV AS 1105-18FT



## Surgicals & Instruments

Quality is Reward of Hardwork

### MICRO NEEDLE HOLDERS

#### Jacobson Micro Needle Holder

- Round Bodied
- Tungsten Carbide Jaws
- 1.2 mm Jaws



With Lock	Straight	Curved	Without Lock	Straight	Curved
15cm/6"	MV AS 1007-15	MV AS 1008-15	15cm/6"	MV AS 1107-15	MV AS 1108-15
18cm/7"	MV AS 1007-18	MV AS 1008-18	18cm/7"	MV AS 1107-18	MV AS 1108-18
21cm/8 1/4"	MV AS 1007-21	MV AS 1008-21	21cm/8 1/4"	MV AS 1107-21	MV AS 1108-21
23cm/6"	MV AS 1007-23	MV AS 1008-23	23cm/9"	MV AS 1107-23	MV AS 1108-23

#### Jacobson Heavy Style Needle Holder

- Round Bodied
- Diamond Dusted Jaws
- For Larger Needles - 3/0 size
- Straight Jaws

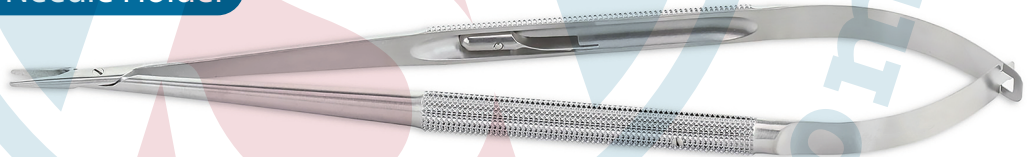

With Lock		Without Lock	
18cm/7"	MV AS 1017-18	18cm/7"	MV AS 1117-18
23cm 9"	MV AS 1017-23	23cm/9"	MV AS 1117-23
25cm/10"	MV AS 1017-25	25cm/10"	MV AS 1117-25

#### Titanium Jacobson Heavy Style Needle Holder

- Round Bodied
- Diamond Dusted Jaws
- For Larger Needles - 3/0 size
- Straight Jaws



With Lock		Without Lock	
18cm/7"	MV AS 1017-18TT	18cm/7"	MV AS 1117-18T
23cm 9"	MV AS 1017-23T	23cm/9"	MV AS 1117-23T
25cm/10"	MV AS 1017-25T	25cm/10"	MV AS 1117-25T



## Surgicals & Instruments

Quality is Reward of Hardwork

### MICRO NEEDLE HOLDERS

#### Barraquer Micro Needle Hoder

- Round Bodied
- 0.4mm Jaws

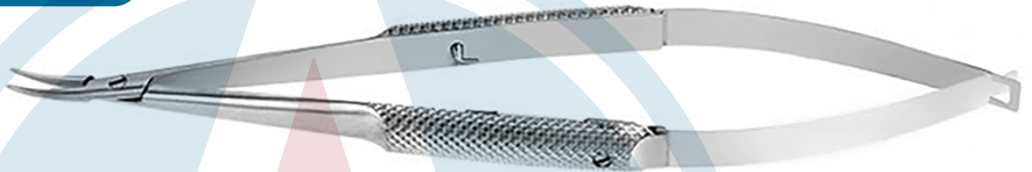

Without Lock

Straight

Curved

13cm/6"

BS AS -13-8

BS AS -13-8

15cm/7"

BS AS -15-8

BS AS -15-8

18cm/7"

BS AS -18-8

BS AS -18-8

#### Castroviejo Micro Needle Hoder

- Flat Hnded
- 0.4mm Jaws

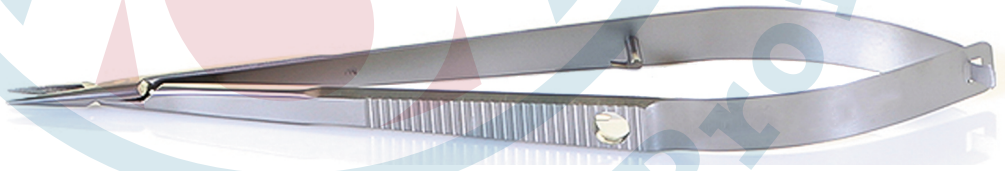

Without Lock

Curved

14cm/5 1/2"

C-14

18cm/7"

C-18

#### Double Action Micro Needle Hoder

- Round Bodied
- 0.4mm Jaws



Without Lock

Curved

15cm/6"

NH AS -15 RM-8

18cm/7"

NH AS -18 RM-8



## Surgicals & Instruments

Quality is Reward of Hardwork

### BAYONET MICRO NEEDLE HOLDERS

#### Yasargil Bayonet Micro Needle Hoder

- Flat Handled
- Delicate 1mm Jaws



With Lock  
23cm/9"

Straight

CV AS -1012-23

Curved

CV AS -1013-23

Without Lock

23cm/9"

Straight

CV AS -1112-23

Curved

CV AS -1113-23

#### Bayonet Micro Needle Hoder

- Round Bodied
- Delicate 1mm Jaws

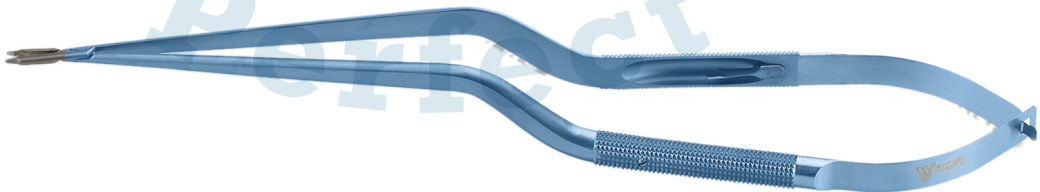

With Lock

21cm / 8<sup>1</sup>/<sub>4</sub>"

21cm / 9"

Straight

MV AS -1010-21

MV AS 1010-23

Curved

MV AS 1011-21

MV AS 1011-23

Without Lock

21cm / 8<sup>1</sup>/<sub>4</sub>"

23cm / 9"

Straight

MV AS 1110-21

MV AS 1110-21

Curved

MV AS 1111-21

MV AS 1111-23



## Surgicals & Instruments

Quality is Reward of Hardwork

### RING HANDLED NEEDLE HOLDERS

#### Draft Needle Holder

- Draft needle Holder
- 12cm / 4<sup>1</sup>/<sub>4</sub>" TC



703DE-AS12

Smooth



705DE-AS12

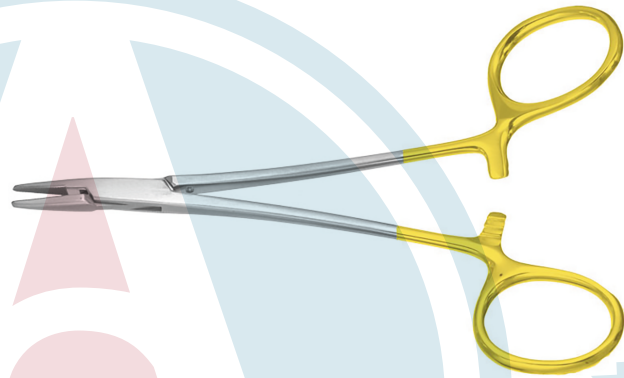

#### Halsey Needle Holder

- Halsey Needle Holder
- 13cm / 5" TC



706DE-AS13

Smooth



704DE-AS13

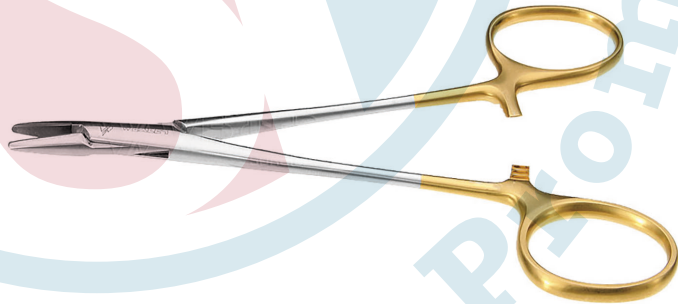

#### Niverts Needle Holder (Offset ring)

- Niverts Needle Holder (Offset ring)
- 13cm / 5" TC



783DE-AS13

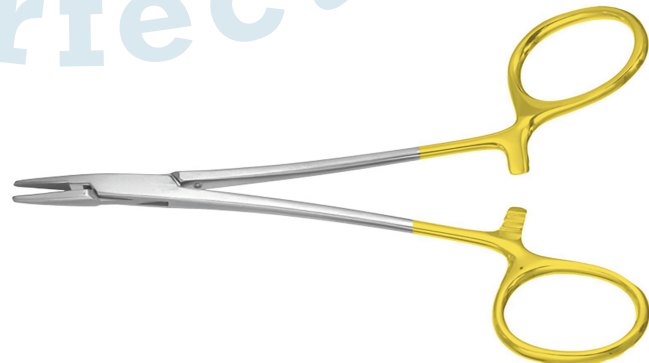
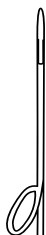





## Surgicals & Instruments

Quality is Reward of Hardwork

### RING HANDLED NEEDLE HOLDERS

#### Mayo Hegar Needle Holder

- Tungsten Carbide Inserts
- Heavy Jaws

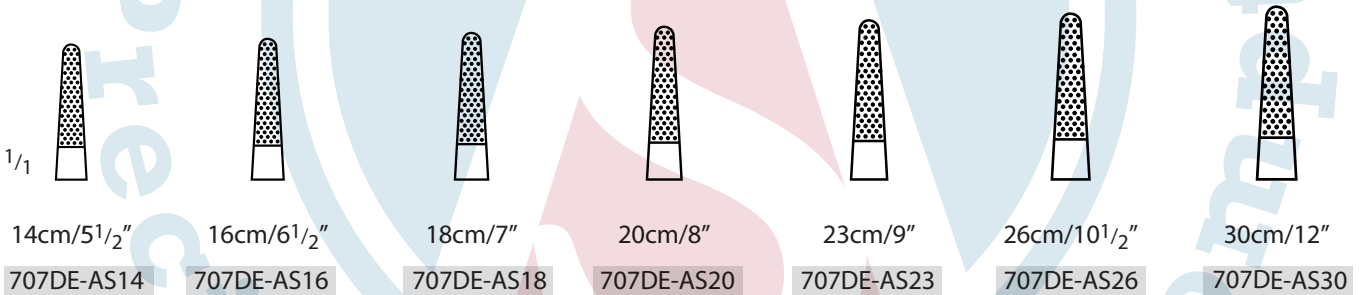

#### Crile Wood Needle Holder

- Tungsten Carbide Inserts
- Fine jaws

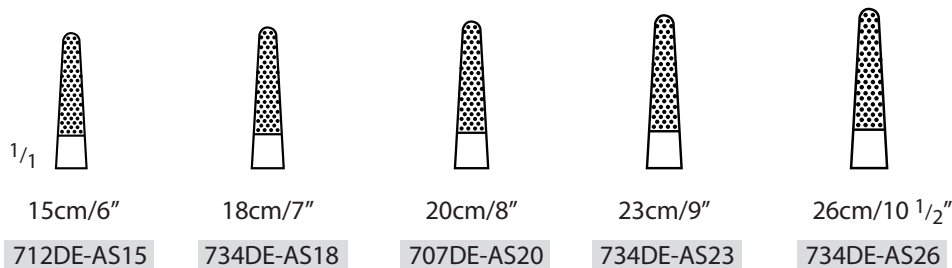
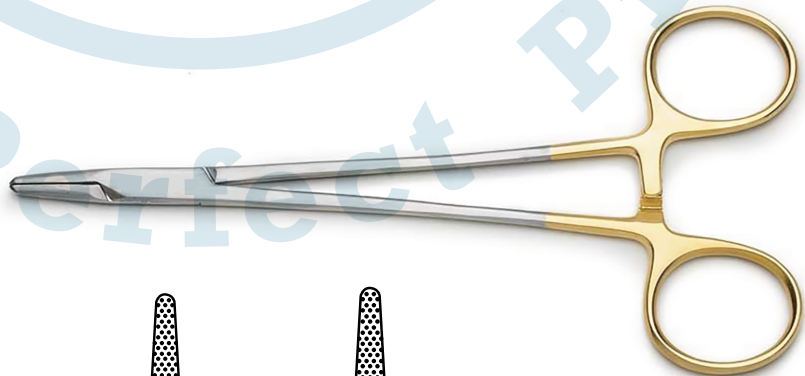



## Surgicals & Instruments

Quality is Reward of Hardwork

### RING HANDLED NEEDLE HOLDERS

#### Micro Ryder Needle Holder

- Tungsten Carbide Inserts

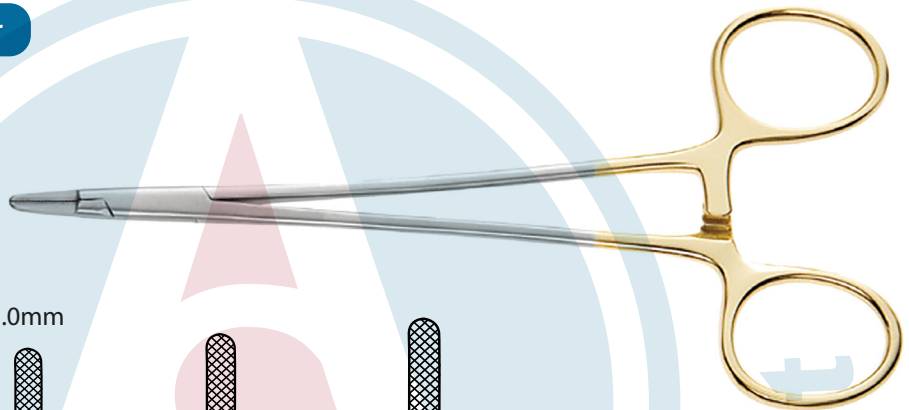
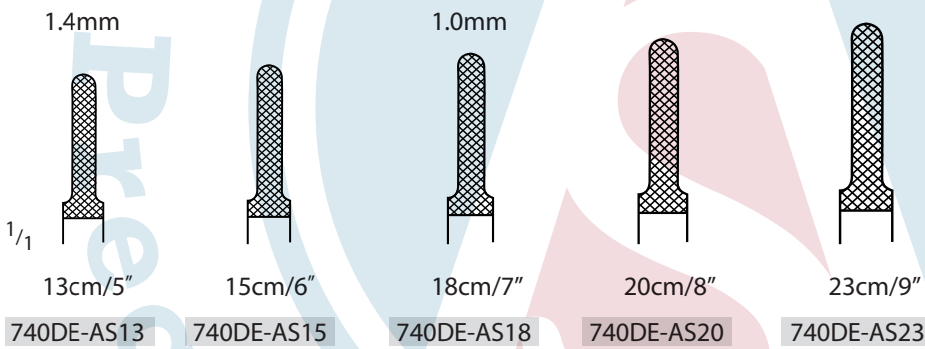

#### French Eye (Ryder) Needle Holder

- Tungsten Carbide Inserts

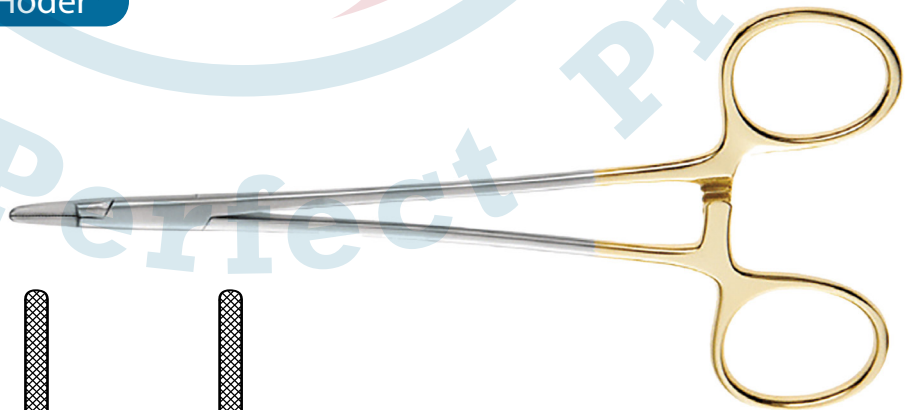
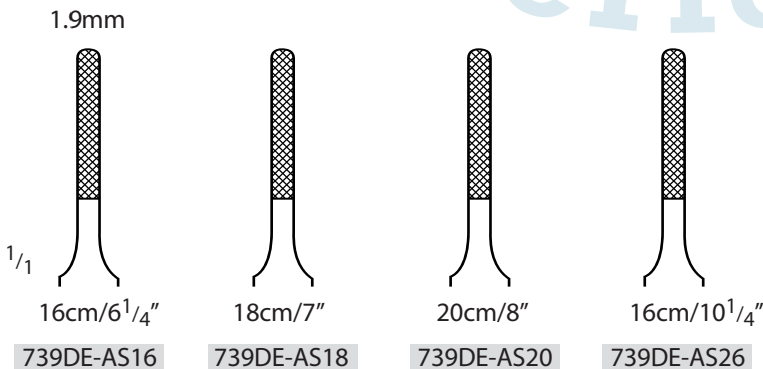



## Surgicals & Instruments

Quality is Reward of Hardwork

### RING HANDLED NEEDLE HOLDERS

#### Fine Touch Needle Hoder

- Diamond Dusted jaws
- Delicate 1 mm Jaws
- For 5/0 Sutures or smaller



1.0mm Jaws

16cm/6<sup>1</sup>/<sub>4</sub>"

MV-AS1018-16

18cm/7"

MV-AS1018-18

22cm/8<sup>1</sup>/<sub>4</sub>"

MV-AS1018-22

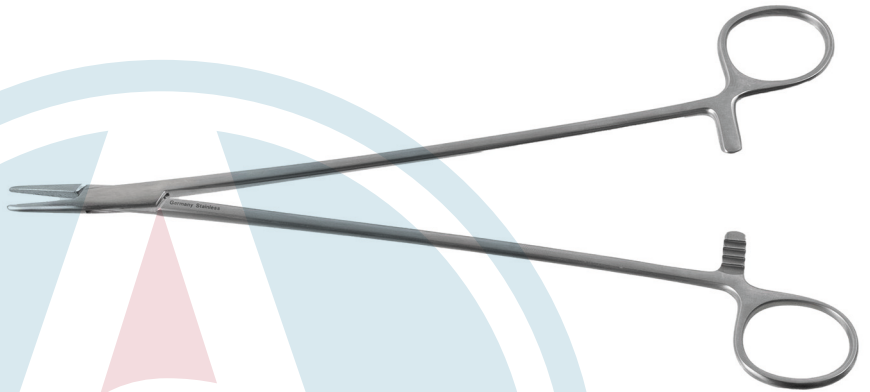

#### Stratte Needle Hoder

- Tungsten Carbide Inserts
- Curved to side
- 23cm/9" length



1/1

732DE-AS23

Illustrated



733DE-AS23

Stratte reverse

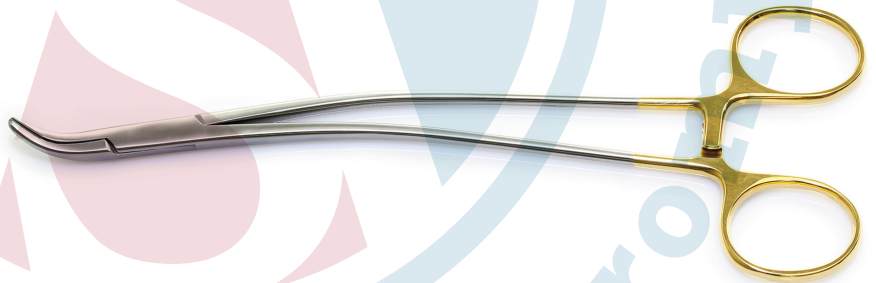

#### Berry Sternal Needle Hoder

- Tungsten Carbide Inserts

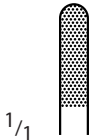

1/1

18cm/7"

803DE-AS18

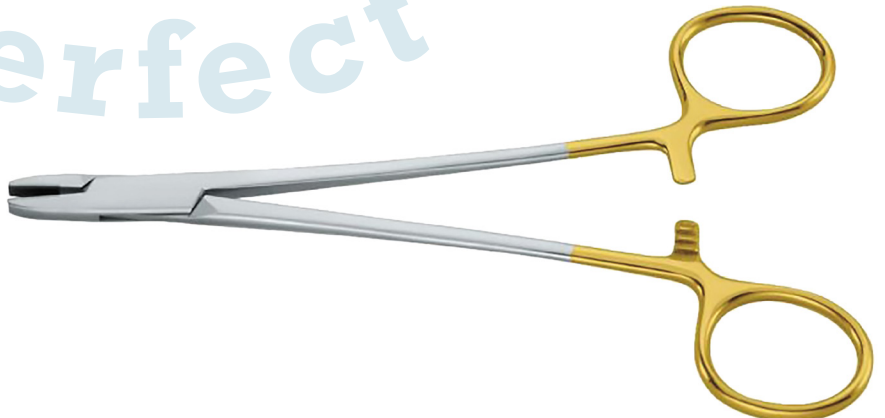



## Surgicals & Instruments

Quality is Reward of Hardwork

### VASCULAR FORCEPS

#### Gillies Dissecting Forceps

- 15cm/6" Length
- Toothed

HA-AS5160-15



#### McIndoes Dissecting Forceps

- 15cm/6" Length
- Non-Toothed

CA-AS5170-15



#### Titanium Cushing Dissecting Forceps

- 18cm/7" Length
- Serrated 1mm Tips

CV-AS2001-18T



#### Adson Bayonet Dissecting Forceps

- 19cm/7<sup>1</sup>/<sub>2</sub>" Length
- Flat-Handled

CV-AS2003-19 Serrated tip

CV-AS2004-19 Toothed





## Surgicals & Instruments

Quality is Reward of Hardwork

### VASCULAR FORCEPS

#### Gerald-DeBakey Forceps

- Flat Handled
- 1.2mm DeBakey Tips

17.5cm/6<sup>1</sup>/<sub>4</sub>" CV-AS2110-17

21cm/8<sup>1</sup>/<sub>4</sub>" CV-AS2110-21

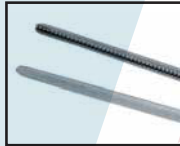

#### Titanium Gerald-DeBakey Forceps

- Flat Handled
- 1.2mm DeBakey Tips

17.5cm/6<sup>1</sup>/<sub>4</sub>" CV-AS2110-17T

21cm/8<sup>1</sup>/<sub>4</sub>" CV-AS2110-21T



#### Gerald Tissue Forceps

- Flat Handed
- Tungsten Carbide Tips
- 1.2mm Tips

17.5cm/6<sup>1</sup>/<sub>4</sub>" CV-AS2111-27



#### Gerald Plain Forceps

- Flat Handled
- Diamond Dusted Tips
- 1mm Tips

17.5cm/6<sup>1</sup>/<sub>4</sub>" CV-AS2114-27





## Surgicals & Instruments

Quality is Reward of Hardwork

### VASCULAR FORCEPS

#### Gerald Platform Forceps

- Flat Handled
- Tying Platform 6 x 1mm
- Diamond Dusted Tips

17.5cm/6<sup>1</sup>/<sub>4</sub>" CV-AS113-17

21cm/8<sup>1</sup>/<sub>4</sub>" CV-AS2113-21

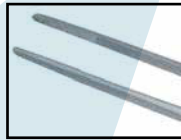

#### Titanium Gerald Platform Forceps

- Flat Handled
- Tying Platform 6 x 1mm
- Diamond Dusted Tips

17.5cm/6<sup>1</sup>/<sub>4</sub>" CV-AS2113-17T

21cm/8<sup>1</sup>/<sub>4</sub>" CV-AS2113-21T



#### Gerald Micro Ring Tip Forceps

- Flat Handled
- 1mmDiamond Dusted Rings

17.5cm/6<sup>1</sup>/<sub>4</sub>" CV-AS2112-17

17.5cm/8<sup>1</sup>/<sub>4</sub>" CV-AS2112-21



#### Titanium Gerald Micro Ring Tip Forceps

- Flat Handled
- 1mmDiamond Dusted Rings

17.5cm/6<sup>1</sup>/<sub>4</sub>" CV-AS2112-27T

21cm/8<sup>1</sup>/<sub>4</sub>" T CV-AS2112-21T





## Surgicals & Instruments

Quality is Reward of Hardwork

### ROUND BODIED MICRO FORCEPS

#### Micro Platform Forceps

- Diamond Dusted Tips



18cm/7"

MV-AS2201-18

21cm/8<sup>1</sup>/<sub>4</sub>"

MV-AS2201-21

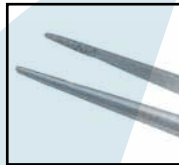

#### Titanium Micro Platform Forceps

- Diamond Dusted Tips



18cm/7"

MV-AS2201-18T

21cm/8<sup>1</sup>/<sub>4</sub>"

MV-AS2201-21T

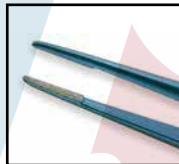

#### Micro Platform Forceps with Counter Balance

- Diamond Dusted Tips



18cm/7"

MV-AS2203-18

21cm/8<sup>1</sup>/<sub>4</sub>"

MV-AS2203-21



#### Titanium Micro Platform Forceps with Counter Balance

- Diamond Dusted Tips

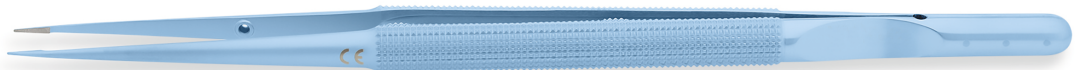

18cm/7"

MV-AS2203-18T

21cm/8<sup>1</sup>/<sub>4</sub>"

MV-AS2203-21T





## Surgicals & Instruments

Quality is Reward of Hardwork

### ROUND BODIED MICRO FORCEPS

#### Micro Ring Tip Forceps

- Diamond Dusted 1 mm Ring

18cm/7"

CV-AS2205-18

21cm/8<sup>1</sup>/<sub>4</sub>"

CV-AS2205-21

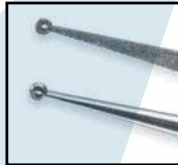

#### Titanium Micro Ring Tip Forceps

- Diamond Dusted 1 mm Ring

18cm/7"

CV-AS2205-18T

21cm/8<sup>1</sup>/<sub>4</sub>"

CV-AS2205-21T



#### Micro Ring Tip Forceps with Counter Balance

- Diamond Dusted 1 mm Ring

18cm/7"

CV-AS2206-18

21cm/8<sup>1</sup>/<sub>4</sub>"

CV-AS2206-21



#### Titanium Micro Ring Tip Forceps with Counter Balance

- Diamond Dusted 1 mm Ring

18cm/7"

CV-AS2206-18T

21cm/8<sup>1</sup>/<sub>4</sub>"

CV-AS2206-21T







## Surgicals & Instruments

Quality is Reward of Hardwork

### MICRO BAYONET FORCEPS

#### Bayonet Micro Forceps

- Round Bodied
- Blunt 1mm Tips

21cm/8<sup>1</sup>/<sub>4</sub>"  
23cm/9"

CV-AS2302-21  
CV-AS2302-23

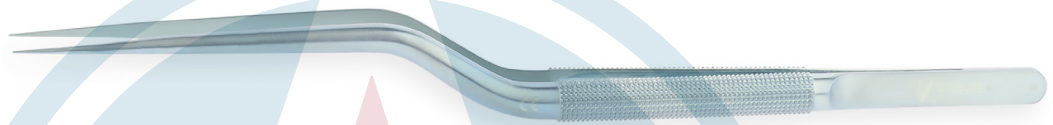

#### Yasargil Bayonet Micro Forceps

- Flat Handled
- Blunt 1mm Tips

22.5cm/8<sup>1</sup>/<sub>4</sub>"  
24cm/9<sup>1</sup>/<sub>4</sub>"

CV-AS2301-22  
CV-AS2301-24



#### Yasargil Bayonet Tumor Grasping Forceps

- Flat Handled
- 22.5cm/8<sup>1</sup>/<sub>4</sub>" Length



Plain Ring

3mmØ  
5mmØ

CV-AS2303-22  
CV-AS2304-22



Serrated Ring

3mmØ  
5mmØ

CV-AS2307-22  
CV-AS2307-22



Toothed Ring

3mmØ  
5mmØ

CV-AS2305-22  
CV-AS2305-22



## Surgicals & Instruments

Quality is Reward of Hardwork

### BIPOLAR FORCEPS

#### Straight Bipolar Forceps

- 10.5cm/8<sup>1</sup>/<sub>4</sub>" Length

Tip Size

0.7 mm AS-70 02 38

1 mm AS-70 02 43

Blunt AS-70 02 41

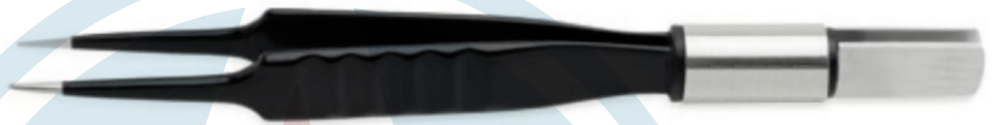

#### Straight Bipolar Forceps

- 16.5cm/6<sup>1</sup>/<sub>2</sub>" Length

Tip Size

0.7 mm AS-70 01 52

1 mm AS-70 01 51



#### Straight Bipolar Forceps

- 19cm/7<sup>1</sup>/<sub>2</sub>" Length

Tip Size

0.7 mm AS-70 01 72

1 mm AS-70 01 71





## Surgicals & Instruments

Quality is Reward of Hardwork

### BIPOLAR FORCEPS

#### Bayonet Bipolar Forceps

- 19cm/7<sup>1</sup>/<sub>2</sub>" Length

Tip Size

0.7 mm AS-70 01 83

1 mm AS-70 01 81

1 mm AS-70 01 82



#### Bayonet Bipolar Forceps

- 22.5cm/8<sup>1</sup>/<sub>4</sub>" Length

Tip Size

0.3 mm AS-70 01 90

0.7 mm AS-70 01 91

1.2 mm AS-70 01 92



#### Bayonet Bipolar Forceps

- 24cm/9<sup>1</sup>/<sub>2</sub>" Length

Tip Size

0.3 mm AS-70 02 90

0.7 mm AS-70 02 91

1.2 mm AS-70 02 92



37-01-35L



- Fitting Block End Forceps
- Banana Plug Vallylab Machine Fitting
- 4.5 metre length

37-01-38L



- Fitting Block End Forceps
- Erbe BM780 Machine Fitting
- 4.5 metre length



## Surgicals & Instruments

Quality is Reward of Hardwork

### BIPOLAR FORCEPS

#### Bayonet Bipolar Coagulation Forceps

- 22.5cm/8¾" Length
- Non-Stick Tips
- Mallis 2 Pin Fitting



#### Tip Size

0.5 mm	AS-10-5402 AU
0.7 mm	AS-10-5403 AUS/0.7
1.0 mm	AS-10-5403 AU
1.3 mm	AS-10-5403 AUS
1.5 mm	AS-10-5401 AU
2.0 mm	AS-10-5401 AUS

10-6000 • Fitting Mallis Forceps • Banana Plug Fitting



#### Bayonet Bipolar Coagulation Unit

##### BM780 MK II

- 70 Watts
- Foot Switch Control

AS-36 - 00 - 80 - 01



36 - 01 - 05 Foot Switch



## Surgicals & Instruments

Quality is Reward of Hardwork

### Straight Bipolar Forceps

- 10.5cm/4¼" Length

Tip Size

0.7mm

AS-70 02 38

1mm

AS-70 02 43

Blunt

AS-70 02 41



### Straight Bipolar Forceps

- 16.5cm/6¼" Length

Tip Size

0.7mm

AS-70 01 52

1mm

AS-70 01 51



### Straight Bipolar Forceps

- 16.5cm/7¼" Length

Tip Size

0.7mm

AS-70 01 72

1mm

AS-70 01 71



### Bayonet Bipolar Forceps

- 19cm/7½" Length

Tip Size

0.7mm

AS-70 01 83

1mm

AS-70 01 81

2mm

AS-70 01 82





## Surgicals & Instruments

Quality is Reward of Hardwork

### BIPOLAR FORCEPS

#### Bayonet Bipolar Forceps

• 23cm/9" Length

Tip Size

0.3mm

AS-70 01 90

0.7mm

AS-70 01 91

1.2mm

AS-70 01 92



#### Bayonet Bipolar Forceps

• 25cm/9 1/4" Length

Tip Size

0.3mm

AS-70 02 90

0.7mm

AS-70 02 91

1.2mm

AS-70 02 92



**37-01-35L**

- Fitting Block End Forceps
- Banana Plug Vallylab Machine Fitting
- 4.5 metre length

**37-01-38L**

- Fitting Block End Forceps
- Erbo EM 780 Machine Fitting
- 4.5 metre length

#### Bayonet Bipolar Forceps Supergliss Non-Stick Tips

• 23cm/9"

0.4 mm

AS-78 01 99 SG

0.7 mm

AS-78 01 9T SG

1.0 mm

AS-78 01 98 SG

1.2 mm

AS-78 01 92 SG



The material specially developed for SuperGliss non-stick forceps prevents overheating of the tips during coagulation. Laboratory tests confirm the outstanding non-stick properties that last through the lifetime of the instrument.





## Surgicals & Instruments

Quality is Reward of Hardwork

### BIPOLAR SCISSORS

#### Bipolar Clamp

- 23cm/9" Length
- Curved Jaws

While bipolar technique is being used, high frequency current flows between the two ends of the bipolar instrument and focuses only on the small surface of tissue placed between them. There is no dangerous flow of current through the patient's body. This minimises the risk of burns in areas that are distant from the surface being operated on. Bipolar techniques are safer than monopolar techniques.

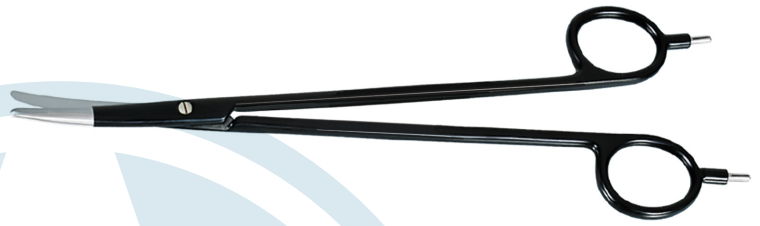

700-731-500

Bipolar Cable for Bipolar Clamp with 2 Banana Plugs, 5m Length.



#### Bipolar Scissors

- Curved Slim Blades
- Metzenbaum Pattern

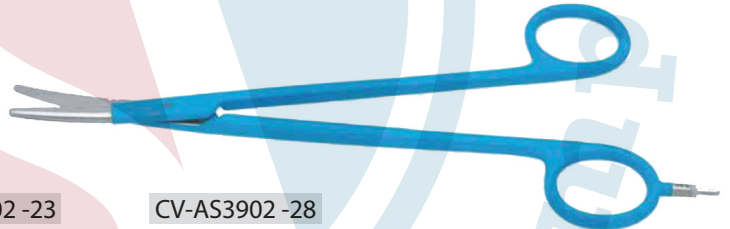

CV-AS3901 -18

18cm/7"

CV-AS3902 -21

21cm/8¼"

CV-AS3902 -23

23cm/9"

CV-AS3902 -28

23cm/11"

#### Bipolar Scissors

- Curved Slim Blades
- Metzenbaum Pattern

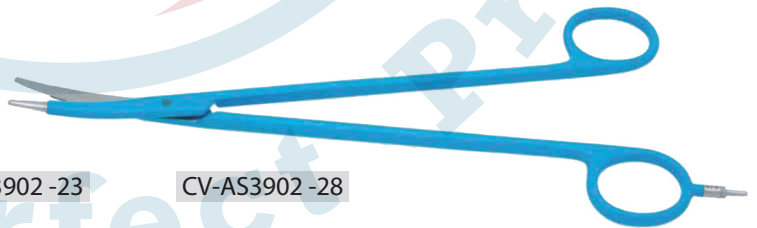

CV-AS3902 -18

18cm/7"

CV-AS3902 -21

21cm/8¼"

CV-AS3902 -23

23cm/9"

CV-AS3902 -28

23cm/11"

#### Bipolar Cables

- For use with Bipolar Scissors
- 5 metre cable



700-736-005 Valleylab



700-736-005 Martin



700-736-005 Banana Plugs





## Surgicals & Instruments

Quality is Reward of Hardwork

### SCISSORS

#### Iris Scissors

- 11.5cm/4½" Straight
- Micro Serrated Cutting Edge

CA-AS7612 -11

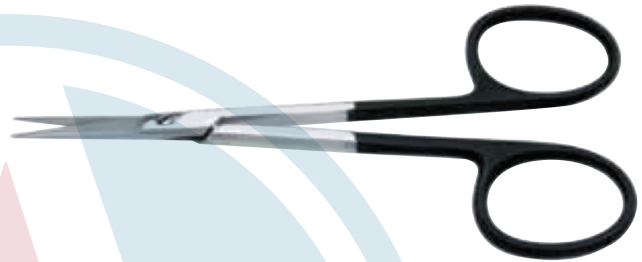
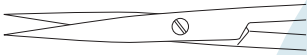

#### Iris Scissors

- 11.5cm/4½" Curved
- Micro Serrated Cutting Edge

CA-AS7613 -11

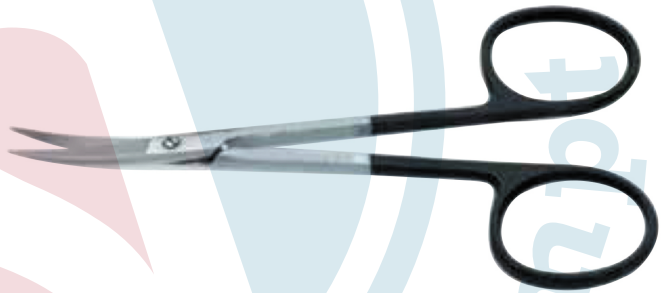
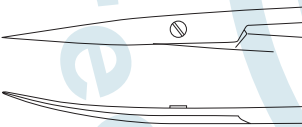

#### Strabismus Scissors

- 11.5cm/4½" Curved
- Micro Serrated Cutting Edge

CA-AS7622 -11

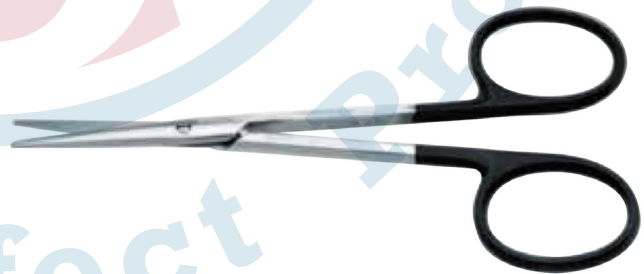

#### Strabismus Scissors

- 11.5cm/4½" Curved
- Micro Serrated Cutting Edge

CA-AS7623 -11







## Surgicals & Instruments

Quality is Reward of Hardwork

### SCISSORS

#### Stevens Tenotomy Scissors

- 11.5cm/4½" Curved
- Micro Serrated Cutting Edge

CA-AS7633 -11



#### Stevens-Stille Pattern Tenotomy Scissors

- 12.5cm/5" Curved
- Micro Serrated Cutting Edge

CA-AS7633 -12



#### Jameson-Weber Scissors

- 13.5cm/5¼" Curved
- Micro Serrated Cutting Edge

CA-AS7643 -13



#### Jameson Scissors

- 15cm/6" Curved
- Micro Serrated Cutting Edge

CA-AS7643 -15



#### Jameson Scissors

- 15cm/6" Curved
- Strong Pattern
- Micro Serrated cutting Edge

CA-AS7645 -15





## Surgicals & Instruments

Quality is Reward of Hardwork

### SCISSORS

#### Slim Baby Metzenbaum Easy-Cut Scissors

- 14cm/5½" Curved
- Micro Serrated Cutting Edge

CA-AS7661 -14

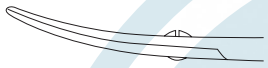

#### Slim Metzenbaum Easy-Cut Scissors

- 18cm/7" Curved
- Micro Serrated Cutting Edge

CA-AS7661 -18

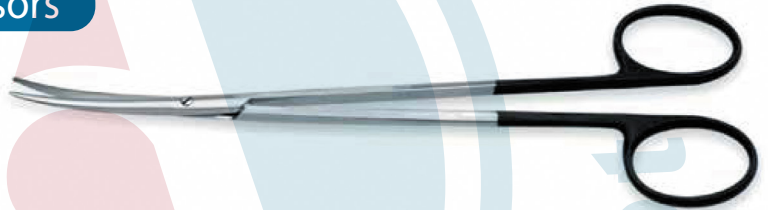

#### Baby Metzenbaum Easy-Cut Scissors

- 14cm/5¼" Curved
- Micro Serrated Cutting Edge

AS-CA-AS7663 -14

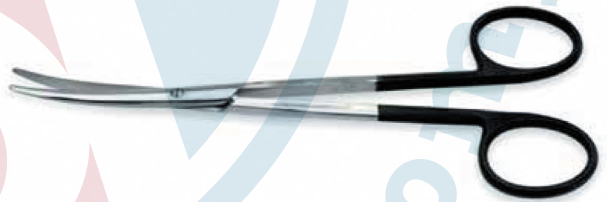

#### Mclmdoe/ Metzenbaum Easy-Cut Scissors

- 18cm/7" Curved
- Micro Serrated Cutting Edge

CA-AS7663 -18

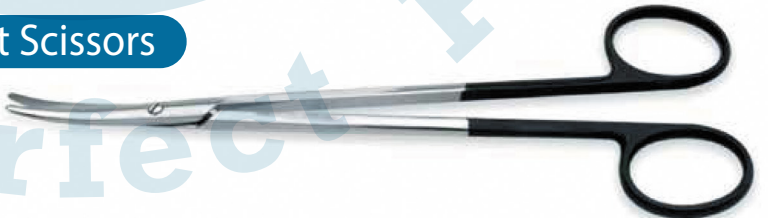

#### Nelson Metzenbaum Easy-Cut Scissors

- 23cm/9" Curved
- Micro Serrated cutting Edge

CA-AS7663 -23





## Surgicals & Instruments

Quality is Reward of Hardwork

### SCISSORS

#### Mayo Easy-Cut Scissors

- 14cm/5½" Curved
- Micro Serrated Cutting Edge

CA-AS7652 -14



#### Mayo Easy-Cut Scissors

- 14cm/5½" Curved
- Micro Serrated Cutting Edge

CA-AS7653 -14

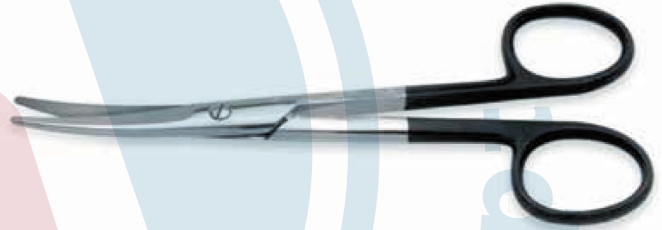
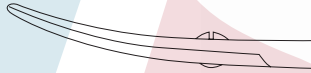

#### Mayo Easy-Cut Scissors

- 17cm/6¼" Straight
- Micro Serrated Cutting Edge

CA-AS7652 -17

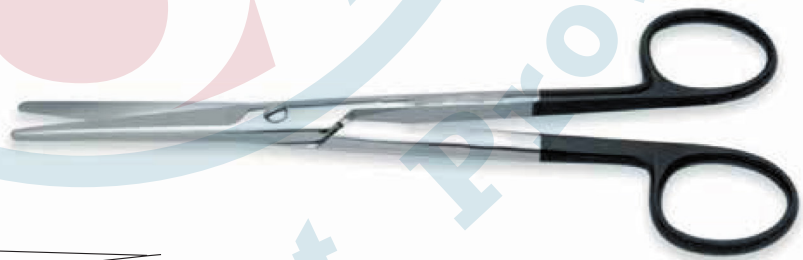

#### Mayo Easy-Cut Scissors

- 17cm/6¾" Curved
- Micro Serrated Cutting Edge

CA-AS7653 -17





## Surgicals & Instruments

Quality is Reward of Hardwork

### DIETRICH SCISSORS

#### Diethrich Coronary Scissors - Standard Pattern

- 18cm/7" Length
- Needle Fine Tips
- Polished Fine Blades
- 12mm Blade length



25° Angled

CV-AS3025 -18



45° Angled

CV-AS3045 -18



60° Angled

CV-AS3060 -18



90° Angled

CV-AS3090 -18



125° Angled

CV-AS3012 -18

#### Diethrich Coronary Scissors - Short Fine Blade

- 18cm/7" Length
- Needle Fine Tips
- Precise Polished Blades
- 8mm Blade length



25° Angled

CV-AS3025 -185



45° Angled

CV-AS3045 -185



60° Angled

CV-AS3060 -185



90° Angled

CV-AS3090 -185



125° Angled

CV-AS3012 -185



## Surgicals & Instruments

Quality is Reward of Hardwork

### DIETHRICH SCISSORS

#### Diethrich Coronary Scissors - Extra Long Delicate Blades

- 18cm/7" Length
- Needle Fine Tips
- Precise Polished Blades
- 15mm Blade length



25° Angled  
CV-AS3025 -18L



45° Angled  
CV-AS3045 -18L

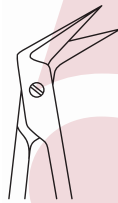

60° Angled  
CV-AS3060 -18L



90° Angled  
CV-AS3090 -18L



125° Angled  
CV-AS3012 -18L



#### Diethrich Coronary Scissors - with Guide Rail

- 18cm/7" Length
- 12mm Blade length
- 125° Angled Blades

CV-AS3113 -18 G



#### Favaloro Coronary Scissors

- 17cm/6½" Length
- 12mm Blade length
- 125° Angled Blades

CV-AS3113 -18





## Surgicals & Instruments

Quality is Reward of Hardwork

### SCISSORS

#### Potts-Smith Vascular Scissors

- 19cm/7½" Length
- Blades angles to side

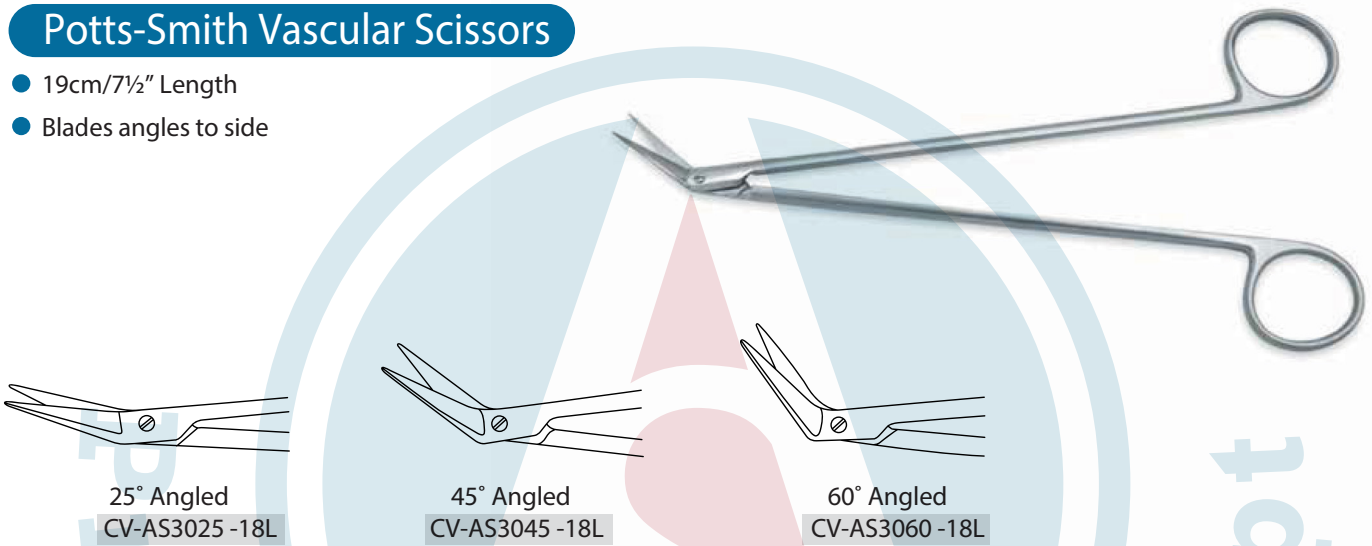

25° Angled  
CV-AS3025 -18L

45° Angled  
CV-AS3045 -18L

60° Angled  
CV-AS3060 -18L

#### Jacobson Bayonet Micro Scissors

- Flat Handled
- 18cm/7" Length



Straight  
CV-AS3009 -18

Curved  
CV-AS3010 -18

#### Yasargil bayonet Micro Scissors

- Flat Handled
- 22.5cm/8¾" Length



Standard Blade



Straight  
CV-AS3005 -22



Curved  
CV-AS3006 -22

Vannas Blade



Straight  
CV-AS3007 -22



Curved  
CV-AS3008 -22



## Surgicals & Instruments

Quality is Reward of Hardwork

### MICRO CORONARY SCISSORS

#### Castroviejo Micro Scissors

- Flat Handled
- 19cm/4½" Length
- 45° Angled Blades
- 14mm Blade length

CV-AS3045 -90

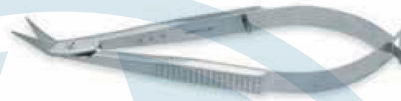

#### Castroviejo Micro Scissors

- Round Handled
- 11cm/4½" Length
- 45° Angled Blades
- 14mm Blade length

CV-AS3145 -11

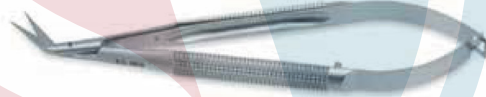

#### Micro Coronary Scissors - Standard 10mm Blades

- Round Handled - Short length
- 14cm/5½" Length
- Blades angled to side

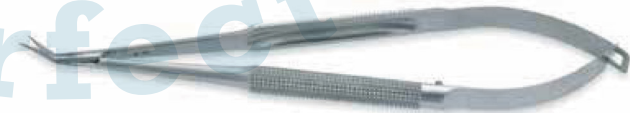

25° Angled  
CV-AS3125 -14



45° Angled  
CV-AS3145 -14



60° Angled  
CV-AS3160 -1



90° Angled  
CV-AS3190 -14



125° Angled  
CV-AS3112 -14



# Alliance

## Surgicals & Instruments

Quality is Reward of Hardwork

### MICRO CORONARY SCISSORS

#### Micro Coronary Scissors - Standard 10mm Blades

- Round Handled
- 18cm/7" Length
- Blades angled to side

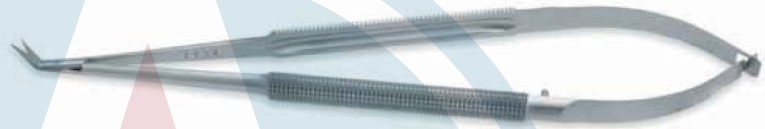

25° Angled  
CV-AS3125 -18



45° Angled  
CV-AS3145 -18



60° Angled  
CV-AS3160 -18



90° Angled  
CV-AS3190 -1



125° Angled  
CV-AS3112 -18

#### Micro Coronary Scissors - Short Fine 8mm Blades

- Round Handled
- 18cm/7" Length
- Blades angled to side

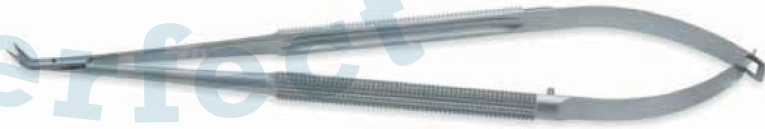

25° Angled  
CV-AS3325 -18



45° Angled  
CV-AS3345 -18



60° Angled  
CV-AS3360 -18



90° Angled  
CV-AS3390 -14



125° Angled  
CV-AS3312 -18





## Surgicals & Instruments

Quality is Reward of Hardwork

### MICRO CORONARY SCISSORS

#### Micro Coronary Scissors - Standard 10mm Blades

- Flat Handled
- 18cm/7" Length
- Blades angled to side



25° Angled  
MV-AS3425 -18



45° Angled  
MV-AS3445 -18

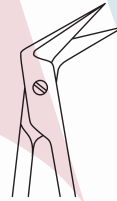

60° Angled  
MV-AS3460 -18



90° Angled  
MV-AS3490 -1



125° Angled  
MV-AS3412 -18

#### Micro Coronary Scissors - Standard Fine 8mm Blades

- Flat Handled
- 18cm/7" Length
- Blades angled to side

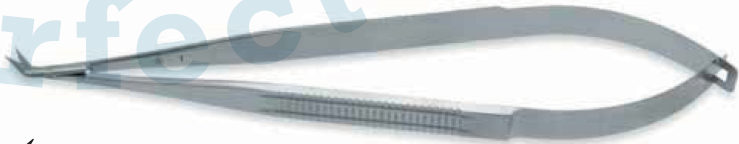

25° Angled  
CV-AS3625 -18



45° Angled  
CV-AS3645 -18



60° Angled  
CV-AS3660 -18

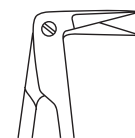

90° Angled  
CV-AS3690 -14



125° Angled  
CV-AS3612 -18



## Surgicals & Instruments

Quality is Reward of Hardwork

### MICRO SCISSORS

#### Straight Micro Scissors

- Round Handled
- 15cm/6" Length
- Blades 19mm long

CAS-AS - 15

Adventita Scissors with pointed tips

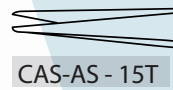
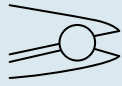

CAS-AS - 15T

Available with Micro Serrations for nerve cutting - straight

#### Curved Micro Scissors

- Flat Handled
- 15cm/6" Length
- Blades 19mm long

CDC-AS - 15

Dissecting Scissors with rounded tips

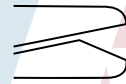

CDC-AS - 15T

Available with Micro Serrations for nerve cutting - Curved

#### Straight Micro Scissors

- Round Handled
- 15cm/6" Length
- Blades 15mm long

CAS-AS - 15S

Adventita Scissors with pointed tips

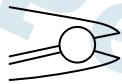

#### Curved Micro Scissors

- Round Handled
- 15cm/6" Length
- Blades 15mm long

CDC-AS- 15S

Dissecting Scissors with rounded tips





## Surgicals & Instruments

Quality is Reward of Hardwork

### MICRO SCISSORS

#### Straight Micro Scissors

- Round Handled
  - 15cm/6" Length
  - Blades 12mm long
- CAS-AS - 15 RB

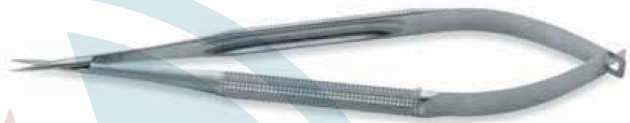

Adventita Scissors with pointed tips

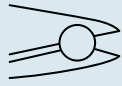

#### Curved Micro Scissors

- Flat Handled
  - 15cm/6" Length
  - Blades 12mm long
- CDC-AS - 15 RB



Dissecting Scissors with rounded tips

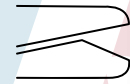

#### Straight Micro Scissors

- Round Handled
  - 18cm/7" Length
  - Blades 14mm long
- CAS-AS - 18 RB

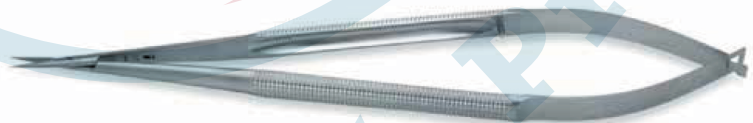

Adventita Scissors with pointed tips

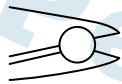

#### Curved Micro Scissors

- Round Handled
  - 18cm/7" Length
  - Blades 14mm long
- CDC-AS- 18 RB



Dissecting Scissors with rounded tips

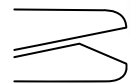



## Surgicals & Instruments

Quality is Reward of Hardwork

### RIB SPREADERS

#### Finochietto Rib Spreader



Code	Blade width	Blade depth	spread
CV-AS 5004 - 18	21mm	18mm	85mm
CV-AS 5004 - 18	21mm	18mm	85mm
CV-AS 5004 - 18	21mm	18mm	85mm
CV-AS 5004 - 18	21mm	18mm	85mm
CV-AS 5004 - 18	21mm	18mm	85mm

#### Sellors Rib Spreader

CV-AS 5011 - 00

Supplied with set of 3 sizes of Blades and key

Small Blade	38mm Depth
Medium Blade	45mm Depth
Large Blade	65mm Depth

● Max spread 225mm

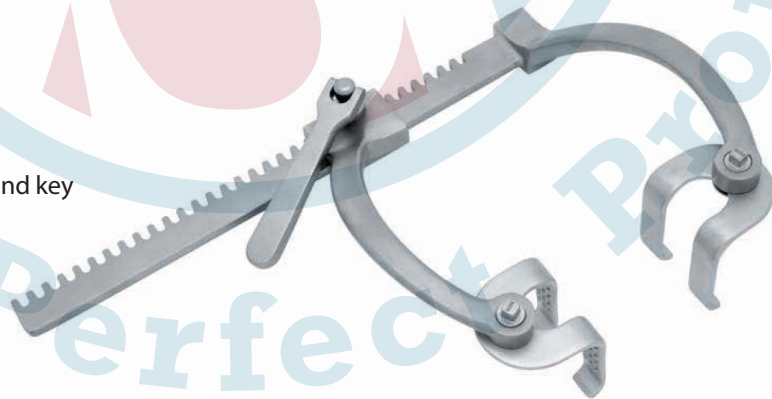

38mm Depth  
Small Blade



45mm Depth  
Medium Blade



45mm Depth  
Large Blade



Key



## Surgicals & Instruments

Quality is Reward of Hardwork

### RIB SPREADERS

#### Tuffer Rib Spreader

CV-AS 5005 - 50

Blade width	Blade depth
45mm	50mm



#### Tudor Edwards Modified Tuffer Rib Spreader

- Complete with key

CV-AS 5006 - 35

Blade width	Blade depth
45mm	50mm

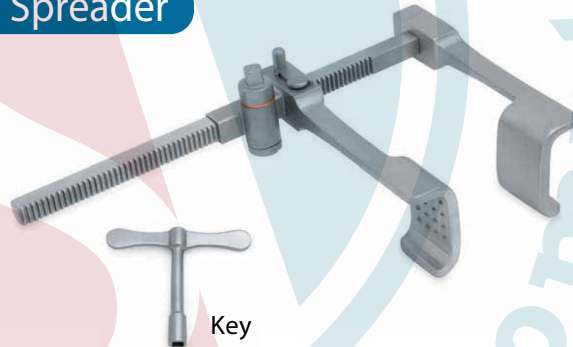

#### Tudor Edwards Rib Spreader

CV-AS 5007 - 00

Supplied with set of 3 sizes of Blades and key

Small Blade	25mm Depth
Medium Blade	50mm Depth
Large Blade	75mm Depth



25mm Depth  
Small Blade



50mm Depth  
Medium Blade



75mm Depth  
Large Blade



Key



## Surgicals & Instruments

Quality is Reward of Hardwork

### RIB SPREADERS

#### Ronald Edwards Rib Spreader

- Curved arms, fenestrated Blades



Code		Blade width	Blade depth	Spread
CV-AS 5008 - 50	Medium	30mm	50mm	135mm
CV-AS 5008 - 75	Large	65mm	75mm	205mm

#### Papworth Rib Spreader

- 225mm spread

CV-AS 5009 - 25

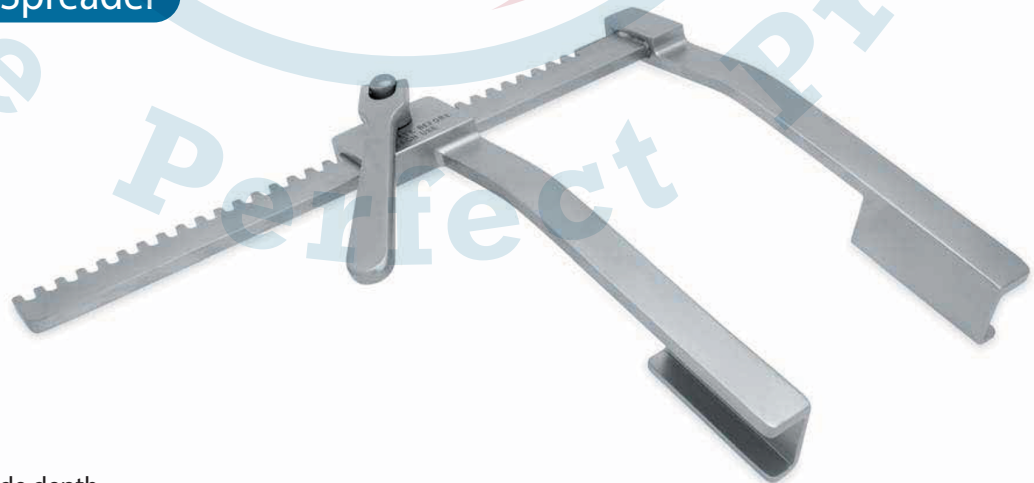

Blade width	Blade depth
65mm	25mm



## Surgicals & Instruments

Quality is Reward of Hardwork

### RIB SPREADERS

#### Sellors Rib Approximator and Spreader Combined

- 20cm/8" length

CV-AS 5010- 00



#### IMA Rib Spreader

- Complete set for Internal Mammary Artery Surgery
- Converts left or right side

Complete set include:

- Frame
- Channelled Blade 100mm
- Claw Blade short 28mm
- Claw Blade long 32mm

CV-AS 5014 - 00



#### Channeled Blade

- 100mm long x 20mm wide



#### Claw Blades



#### Lengths

- 28mm
- 32mm
- 38mm
- 43mm
- 50mm

Included in Set



## Surgicals & Instruments

Quality is Reward of Hardwork

### RIB SPREADERS

#### Sellors Rib Approximator and Spreader Combined

- 20cm/8" length

CV-AS 5010- 00



#### IMA Rib Spreader

- Complete set for Internal Mammary Artery Surgery  
Converts left or right side

Complete set include:

- Frame
- Channelled Blade 100mm
- Claw Blade short 28mm
- Claw Blade long 32mm

CV-AS 5014 - 00

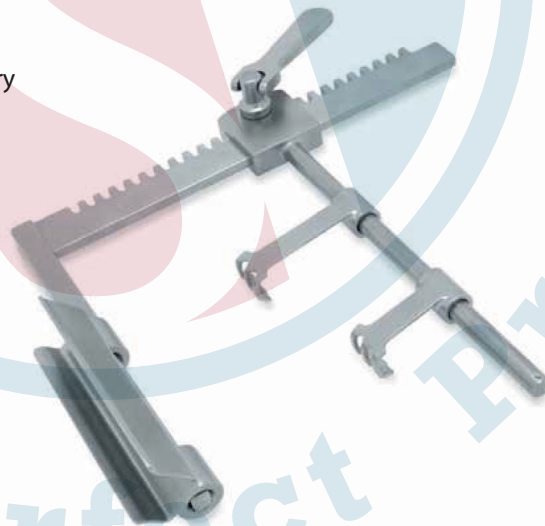

#### Channeled Blade

- 100mm long x 20mm wide



#### Claw Blades



#### Lengths

28mm  
32mm  
38mm  
43mm  
50mm

Included in Set





## Surgicals & Instruments

Quality is Reward of Hardwork

### ABDOMINAL RING RETRACTOR SYSTEM

#### Abdominal Ring Retractor System Cooley Cosgrove Mitral Valve Retractor

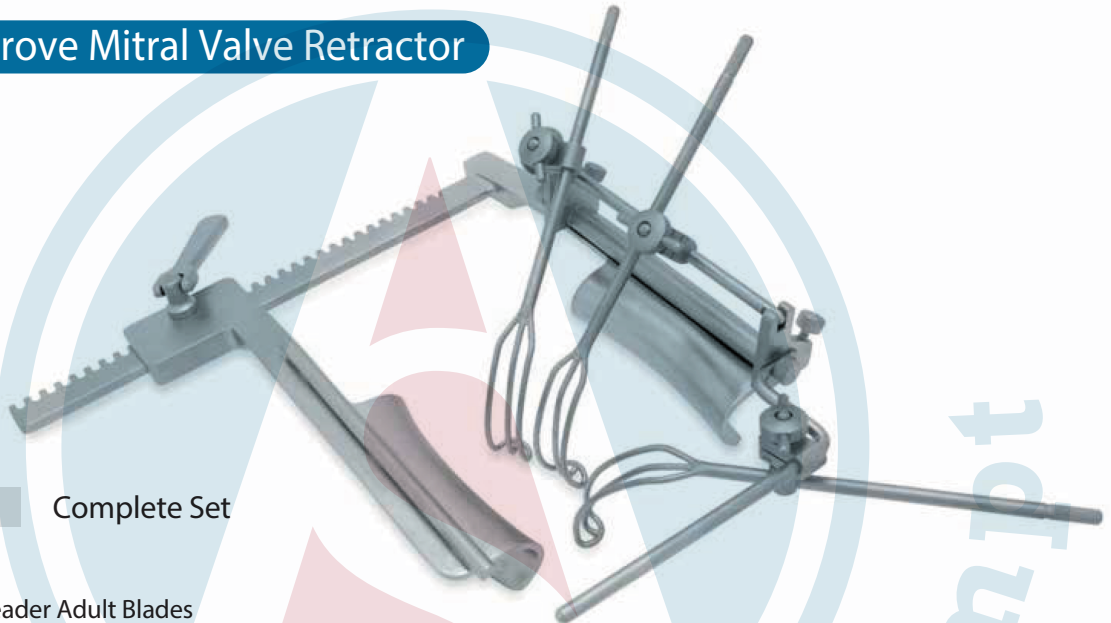

CV-AS 5012- 01

Consisting of:

- 1x Table Post
- 1x Horizontal
- 1x Horizontal

● CV-AS 5012- 00 Complete Set

- 1x Medium O

Consisting of:

- 1x Segment
- 1x Cooley Rib Spreader Adult Blades 40 mm x 110 mm with Cosgrove mounting Bars

Components:

- 1x Main Bracket Attachment
- 1x Universal Clamps
- 1x Side Arm Bar
- 1x Large Retractor Blade
- 1x Small Retractor Blade
- 1x Horizontal Bar

Complete Set

Retractor Blade Large

CV-AS 5012 - 01

Retractor Blade Small

CV-AS 5012 - 02

Tricuspid Retractor Blade

CV-AS 5012 - 03

CV: Universal Clamp  
MV-AS 5012 - 06



Main Bracket Attachment

MV-AS 5012 - 05

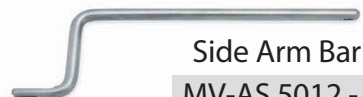

Side Arm Bar  
MV-AS 5012 - 05



## Surgicals & Instruments

Quality is Reward of Hardwork

### RETRACTORS & HOOKS

#### Jacobson Micro Vessel Probe

- 18.5cm/7¼"
- Probe with ball tip

CV-AS 9109 - 18



#### Krayenbühl Nerve and Vessel Hook

- 18.5cm/7¼"

CV-AS 9111 - 18

CV-AS 9112 - 18

MV-AS 9113 - 18

MV-AS 9114 - 18



#### Adson Dural Hook

- 19cm/7½"
- 2mm tip length
- Sharp
- Blunt

CP-AS 9103 - 19

CP-AS 9104 - 19



#### Cushing Blunt Hook

- 19cm/7½"
- 3mm tip length

CV-AS 9101 - 19



#### Crile Blunt Hook

- 20cm/8"
- 5-7mm tip length

SP-AS 9111- 20



#### Adson Hook

- 20cm/8"
- 5mm tip length

Sharp

Blunt

CP-AS 9101 - 20

CP-AS 9102 - 20



#### Blalock Blunt Hook

- 24cm/9½"
- 5mm tip length

CP-AS 9103- 24





## Surgicals & Instruments

Quality is Reward of Hardwork

### Gillies Skin Hook

- 18cm/7"

CA-AS 5065 - 01 Small size

CA-AS 5065 - 02 large size



### Klienert-Kutz Skin Hook

- 16cm/6¼"

CA-AS 5055- 01



### Ragnell-Davies Retractor

- 14cm/5½"

CA-AS 5287- 14



### Mini-Langenbeck Retractor

- 16cm/6½"

CA-AS 5242 - 10 10 x 6mm Illustrated

CA-AS 5242 - 17 17 x 5mm



### Desmarres Saddle Retractor

- 16cm/6¼"
- 12mm width

CA-A S5235- 12



### Senn-Miller Double Ended Catspaw Retractor

- 16cm/6¼"

CA-AS 5242 - 10 Sharp prongs

CA-AS 5242 - 17 Blunt prongs



### Kilner-Miniature Pattern Catspaw Retractor

- 15cm/6"

CA-AS 5286 - 01





## Surgicals & Instruments

Quality is Reward of Hardwork

### RETRACTORS

#### Langenbeck Retractor

- 21.5cm/8½"



Code	Blade Size		
	Depth	Width	
CP-AS 5122 - 21	22mm	6mm	Small
CP-AS 5145 - 21	45mm	13mm	Medium
CP-AS 5165 - 21	65mm	25mm	Large
CP-AS 5190 - 21	90mm	20mm	X-Large

#### Morris Retractor

- 25cm/9¾"



Code	Blade Size			
	Depth	Width		
CP-AS 5201 - 40	50mm	40mm	CP-AS 5202 - 40	70mm x 40mm
CP-AS 5201 - 50	50mm	50mm	CP-AS 5202 - 50	70mm x 50mm
CP-AS 5201 - 65	50mm	65mm	CP-AS 5202 - 65	70mm x 65mm

#### Deavers Abdominal REtractor



Code	Length	Width	Code	Length	Width
CV-AS 5100 - 25	300mm	25mm	CV-AS 5100 - 50	300mm	50mm
CV-AS 5100 - 30	350mm	25mm	CV-AS 5100 - 75	300mm	75mm
CV-AS 5100 - 38	300mm	38mm			



## Surgicals & Instruments

Quality is Reward of Hardwork

### Tudor Edwards Scapula Retractor

## RETRACTORS

- 20cm/8"
- Toothed blade 50mm x 45mm

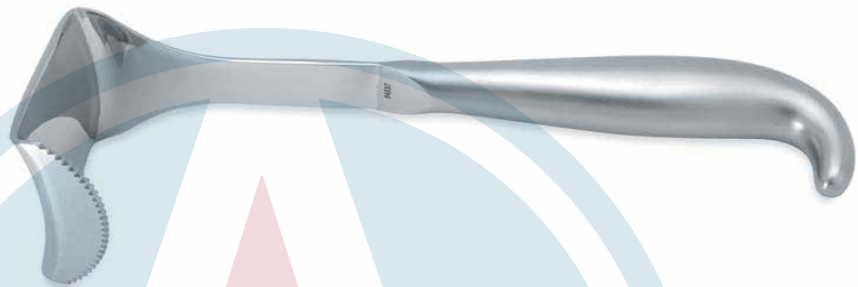

CV-AS 5205 - 20

### Brompton Erector Spine Retractor

- 20cm/8"
- Hollow handle
- 2 Prong Blades

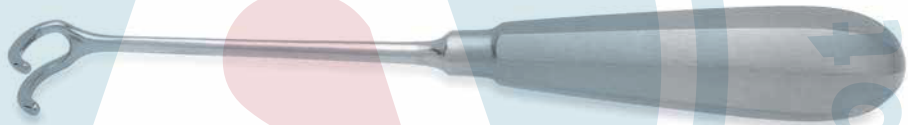

CV-AS 5204 - 20

### Brock Erector Spinae Retractor

- 20cm/8"
- Hollow handle



CV-AS 5203 - 20

### Allison Lung Retractor

Code		Length
CV-AS 5202 - 10	Infant	28cm
CV-AS 5204 - 28	Child	28cm
CV-AS 5206 - 30	Adult	30cm

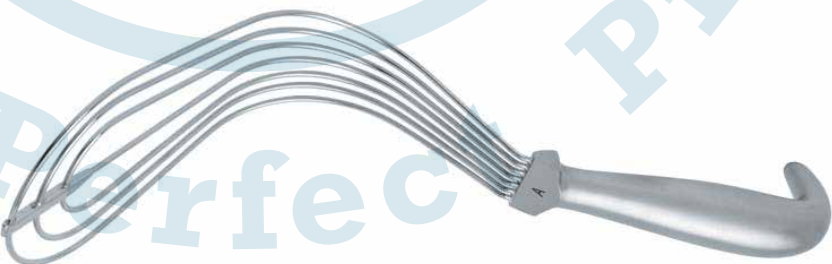

### Ross Aortic Retractor

- 26cm/10½"



Code	Width	Code	Width
CV-AS 5210 - 10	No.1	MV-AS 5210 - 40	No.4
CV-AS 5210 - 20	No.2	MV-AS 5210 - 50	No.5
CV-AS 5210 - 30	No.3	MV-AS 5210 - 60	No.6



## Surgicals & Instruments

Quality is Reward of Hardwork

### RETRACTORS

#### Baby Weitlaner S/R Retractor

- 11.5cm/4½"
- 2 x 3 Blunt Prongs

CA-AS 5701 - 10



#### Wests S/R Retractor

- 14cm/5½"
- 2 x 3 Sharp Prongs
- 

CP-AS 4003 - 14

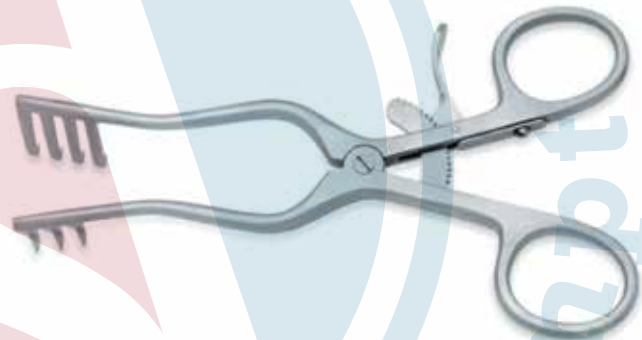

#### Travers S/R Retractor

- 20cm/8"
- 4 x 5 Blunt Prongs

CP-AS 4004 - 20



#### Norfolk and Norwich S/R Retractor

- 20cm/8"
- 4 x 5 Blunt Prongs

SP-AS 4000 - 20





## Surgicals & Instruments

Quality is Reward of Hardwork

### RIB RASPATORY

#### Doyen Periosteal Elevator - Right

CV-AS 7001 - 15 Child - 15cm length

CV-AS 7001 - 15 Adult- 16.5cm length



#### Doyen Periosteal Elevator - Left

CV-AS 7003 - 15 Child - 15cm length

CV-AS 7004 - 15 Adult- 16.5cm length



#### Price Thomas Rib Raspatory

CV-AS 7005 - 12 12mm width

CV-AS 7005 - 20 20mm width

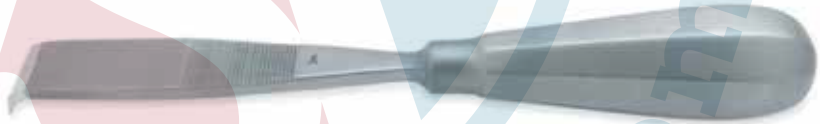

#### Semb Rib Raspatory



No.1

Short shaft  
notched  
end for rib  
edge, 200mm

CV-AS 7006-20



No.2

Long shaft  
notched  
end for rib  
edge, 235mm

CV-AS 7006-23



No.3

Short shaft  
straight  
end  
190mm

CV-AS 7007-19



No.4

Long shaft  
straight  
end  
250mm

CV-AS 7007-25



No.5

Short shaft  
oval  
blade  
220mm

CV-AS 7008-22



No.6

Short shaft  
angled oval  
end for back  
of first rib, 195mm

CV-AS 7009-19



No.7

Long shaft  
for edge of  
first rib  
250mm

CV-AS 7010-25



No.8

Chisel end for  
disarticulation  
of costo vertebral  
200mm

CV-AS 7011-20



# Alliance

## Surgicals & Instruments

Quality is Reward of Hardwork

### RIB CUTTERS

#### Stille-Liston Bone Cutters

- 27cm/10¾"
- Double Action
- Straight

CP-AS 1024-27



#### Liston-Key-Horsley Bone Cutters

- 27cm/10¾"
- Double Action
- Angled

CP-AS 1023-27

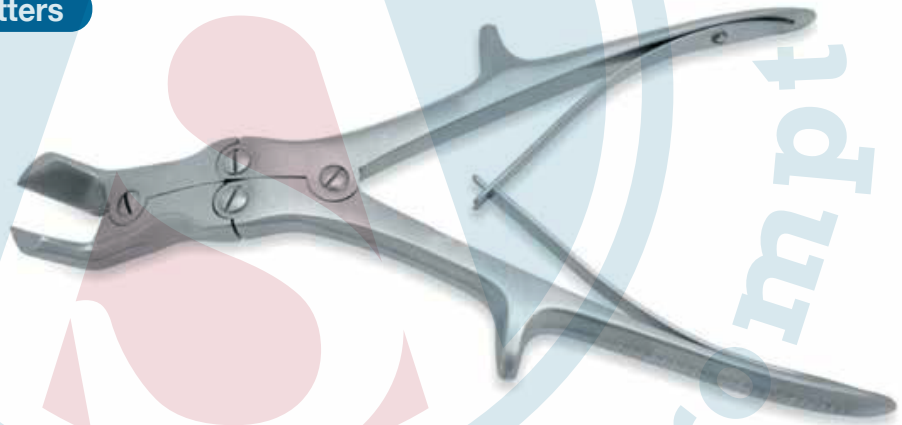

#### Tudor Edwards/Vehmehren Costotome

- 24cm/9½"
- For Cutting Ribs

CP-AS 1023-24







## Surgicals & Instruments

Quality is Reward of Hardwork

### Muller Claus Wire Cutters

- 16cm/6"
- Tungsten Carbide Edges
- Cuts wire up to 1.6mm  $\varnothing$

AS-8-810E16



### Muller Claus Wire Cutters

- Tungsten Carbide Edges
- 18cm/7" length (\*Illustrated)
- Cuts wire up to 2mm  $\varnothing$

AS-8-810E16

AS-8-800E22

22cm/8 $\frac{3}{4}$ " length

Cuts wire up to 1.7mm  $\varnothing$



### End Wire Cutters

- 18cm/7" length
- Tungsten Carbide Edges
- Cuts wire up to 2mm  $\varnothing$

AS-8-816E18



### Muller Claus Wire Pullers

- 18cm/7" length

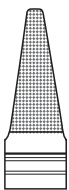

2mm Jaws

AS-8-818E18

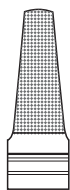

4mm Jaws

AS-8-820E18

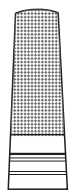

6mm Jaws

AS-8-821E18





## Surgicals & Instruments

Quality is Reward of Hardwork

### Titanium Micro Round Dissectors

### DISSECTORS

- 19cm/7½"



1mm Small  
CV-AS 8101-19



2mm Medium  
CV-AS 8102-19



3mm Large  
CV-AS 8103-19



### Titanium Micro Elevators

- 19cm/7½"



Curved  
CV-AS 8104-19



Angled  
CV-AS 8105-19



### Titanium Micro Spatula Dissectors

- 19cm/7½"



1mm Small  
CV-AS 8106-19



1.7mm Medium  
CV-AS 8107-19



2mm Large  
CV-AS 8108-19



44

### Titanium Micro Hooks

- 19cm/7½"



90° Semi-Sharp  
CV-AS 8109-19



90° Blunt  
CV-AS 8110-19



45° Semi-Sharp  
CV-AS 8111-19



Straight point Needle  
CV-AS 8112-19



### Titanium Micro Cutters

- 19cm/7½"



Small Cup  
CV-AS 8113-19



Large Cup  
CV-AS 8114-19





## Surgicals & Instruments

Quality is Reward of Hardwork

### DISPOSABLE VESSEL CLAMPS

- Sterile, single use, disposable
- Atraumatic jaws
- Colour coded for better differentiation
- Consistent and reliable closing pressure
- Designed for use on veins and arteries
- Light weight
- Blue, black and purple finish provides excellent contrast in the field
- Radiopaque
- Eliminates cleaning and processing problems
- Economical

#### Single Clamps



#### Double Clamps



### VISIBILITY BACKGROUND MATERIAL

#### TO ASSIST IN VISUALISING MICRO VESSELS DURING SURGERY

Application: For use in Micro Surgical Anastomosis of Micro Vessels under a Microscope to allow the surgeon to better visualize the detail of vessels being closed.

The Visibility Material can be used either with the Grid side up to give the Surgeon a scale of the vessel alternatively the reverse plain side can also be used. The material has a non reflective surface eliminating distractions from theatre lighting and has a non-tacky finish to aid mobilization of the Vessel.

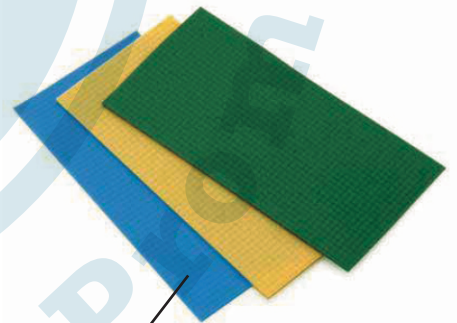

1mm Grid one side & matt finish on reverse, Size: 50 mm x 25 mm

#### Ordering details:

COLOUR	Ordering code
Yellow	VB2
Green	VB3
Blue	VB4

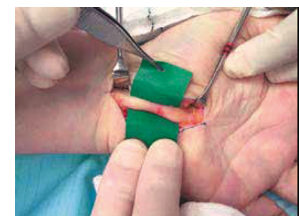
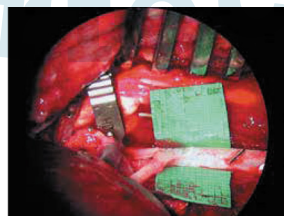

- X-Ray opaque silicon material
- 1mm Grid for accurate measurement of vessels
- latex Free material
- Sterile Packed in boxes of 12 pieces



## Surgicals & Instruments

Quality is Reward of Hardwork

### ACLAND MICRO CLAMPS

"A" or "V" Pattern?

Throughout the series, the "V" pattern is the all-purpose clamp, commonly used on all veins, and almost all arteries. The "A" pattern, available in all sizes, is designed for exceptionally thick-walled vessels and slippery arteries. The slight incurve of the tips of the "A" pattern jaw providers extra security against slippage.

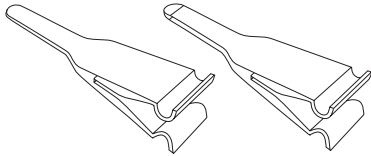

- Light and compact design
- Extremely durable
- A unique gripping surface
- Smooth sliding bar action
- on all approximator clamps
- Clamp profile with parallel sided jaws
- Matt or black finish

Acland  
Clamp Container

CV-AS 4400-00



Double  
Clamp



Single  
Clamp



Ordering details

#### SINGLE CLAMPS

00396 V CLAMP 97E  
00397 A B - 1  
0.4 - 1.0 mm

00398 V B - 2  
00399 A 0.6 - 1.5 mm

00400 V B - 3  
00401 A 0.6 - 2.25 mm

00325 HD - S  
1.5 - 3.5 mm

00286 HD - S  
2.0 - 5.0 mm

#### DOUBLE APPROXIMATING CLAMPS

00414 V CLAMP 97E  
00416 A ABB - 11  
0.4 - 1.0 mm

00416 V ABB - 22  
00417 A 0.6 - 1.5 mm

00418 V ABB - 22  
00419 A 0.6 - 2.25 mm

00326 HD - D  
1.5 - 3.5 mm

00287 HD - D  
2.0 - 5.0 mm

#### DOUBLE CLAMPS WITH FRAME

00408 V CLAMP 97E  
00409 A ABB - 1  
0.4 - 1.0 mm

00410 V ABB - 2  
00411 A 0.6 - 1.5 mm

00412 V ABB - 3  
00413 A 0.6 - 2.25 mm



Clamp  
Box CB-1



Clamp  
Applicator  
CAF - 4



## Surgicals & Instruments

Quality is Reward of Hardwork

### BULLDOG CLAMPS

#### Diethrich Mini Bulldog Clamps

- Straight
- Weight 3gr
- Closing pressure 80gr



Overall Lengtht  
Jaw Length

Code **CV-AS 4001 - 50**



50mm  
8mm

Code **CV-AS 4001 - 55**



55mm  
12mm

Code **CV-AS 4001 - 60**



60mm  
16mm

Code **CV-AS 4001 - 65**

#### Diethrich Mini Bulldog Clamps

- Angled
- Weight 3gr
- Closing pressure 80gr



Overall Lengtht  
Jaw Length

Code **CV-AS 4002 - 43**

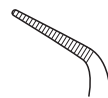

43mm  
8mm

Code **CV-AS 4002 - 45**

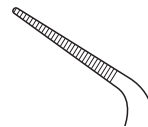

45mm  
12mm

Code **CV-AS 4002 - 50**

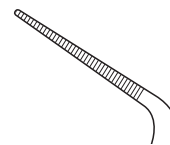

50mm  
16mm

Code **CV-AS 4002 - 55**



## Surgicals & Instruments

Quality is Reward of Hardwork

### BULLDOG CLAMPS

#### DeBakey-Diethrich Mini Bulldog Clamps

- Straight
- Weight 3gr
- Closing pressure 180gr

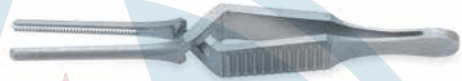

Overall Lengtht  
Jaw Length

47mm  
10mm

51mm  
14mm

57mm  
20mm

Code

CV-AS 4005 - 47

CV-AS 4005 - 51

CV-AS 4005 - 57

#### DeBakey-Diethrich Mini Bulldog Clamps

- Angled
- Weight 3gr
- Closing pressure 180gr

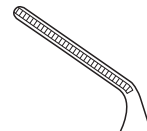
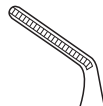

Overall Lengtht  
Jaw Length

44mm  
10mm

46mm  
14mm

49mm  
20mm

Code

CV-AS 4006 - 44

CV-AS 4006 - 46

CV-AS 4006 - 49



## Surgicals & Instruments

Quality is Reward of Hardwork

### BULLDOG CLAMPS

Low Closing Pressure for Veins 110 gr marked with V  
High Closing Pressure for Arteries 220 gr marked with A

#### Titanium Mini Glover Bulldog Clamps

- Straight
- Weight 0.8gr



Overall Length	30mm	35mm	40mm	50mm
Jaw Length	11mm	15mm	17mm	24mm
Vein Low Closing Pressure	CV-AS 4009 - 30T	CV-AS 4009 - 35T	CV-AS 4009 - 40T	CV-AS 4009 - 50T
Arterial High Closing Pressure	CV-AS 4010 - 30T	CV-AS 4010 - 35T	CV-AS 4010 - 40T	CV-AS 4010 - 50T

#### Titanium Mini Glover Bulldog Clamps

- Curved
- Weight 0.8gr



Overall Length				
Jaw Length	CV4011 - 30T	CV4011 - 35T	CV-AS 4011 - 40T	CV-AS 4011 - 50T
Vein Low Closing Pressure	30mm 11mm	35mm 15mm	40mm 17mm	50mm 24mm
Arterial High Closing Pressure	CV-AS 4012 - 30T	CV-AS 4012 - 35T	CV-AS 4012 - 40T	CV-AS 4012 - 50T

#### Titanium Mini Glover Bulldog Clamps

- Curved
- Weight 0.8gr



Overall Length	CV-AS 4013 - 30T	CV-AS 4013 - 35T	CV-AS 4013 - 40T	CV-AS 4013 - 50T
Jaw Length	30mm	35mm	40mm	50mm
Vein Low Closing Pressure	11mm	15mm	17mm	24mm
Arterial High Closing Pressure	CV-AS 4014 - 30T	CV-AS 4014 - 35T	CV-AS 4014 - 40T	CV-AS 4014 - 50T



## Surgicals & Instruments

Quality is Reward of Hardwork

Low Closing Pressure for Veins 110 gr marked with V  
High Closing Pressure for Arteries 220 gr marked with A

### BULLDOG CLAMPS

#### Titanium Mini Glover Bulldog Clamps

- Straight
- Weight 0.8gr



Overall Lengtht

Jaw Length

Vein

Low Closing Pressure  
Arterial

High Closing Pressure

30mm	35mm	40mm	50mm
11mm	15mm	17mm	24mm
<b>CV-AS 4009 - 30T</b>	<b>CV-AS 4009 - 35T</b>	<b>CV-AS 4009 - 40T</b>	<b>CV-AS 4009 - 50T</b>
<b>CV-AS 4010 - 30T</b>	<b>CV-AS 4010 - 35T</b>	<b>CV-AS 4010 - 40T</b>	<b>CV-AS 4010 - 50T</b>

#### Titanium Mini Glover Bulldog Clamps

- Curved
- Weight 0.8gr



Overall Lengtht

Jaw Length

Vein

Low Closing Pressure  
Arterial

High Closing Pressure

30mm	35mm	40mm	50mm
11mm	15mm	17mm	24mm
<b>CV-AS 4011 - 30T</b>	<b>CV-AS 4011 - 35T</b>	<b>CV-AS 4011 - 40T</b>	<b>CV-AS 4011 - 50T</b>
<b>CV-AS 4012 - 30T</b>	<b>CV-AS 4012 - 35T</b>	<b>CV-AS 4012 - 40T</b>	<b>CV-AS 4012 - 50T</b>

#### Titanium Mini Glover Bulldog Clamps

- Curved
- Weight 0.8gr



Overall Lengtht

Jaw Length

Vein

Low Closing Pressure  
Arterial

High Closing Pressure

30mm	35mm	40mm	50mm
11mm	15mm	17mm	24mm
<b>CV-AS 4013 - 30T</b>	<b>CV-AS 4013 - 35T</b>	<b>CV-AS 4013 - 40T</b>	<b>CV-AS 4013 - 50T</b>
<b>CV-AS 4014 - 30T</b>	<b>CV-AS 4014 - 35T</b>	<b>CV-AS 4014 - 40T</b>	<b>CV-AS 4014 - 50T</b>





## Surgicals & Instruments

Quality is Reward of Hardwork

### BULLDOG CLAMPS

#### Glover Bulldog Clamps

- Angled
- 55mm Length jaws



CV-AS 4056 - 55

#### DeBakey-Satinsky Bulldog Clamps

- Curved
- 55mm Length jaws



CV-AS 4057 - 55

#### DeBakey-Carotid Bulldog Clamps

- Curved
- 90mm Length jaws



CV-AS 4058 - 90

#### DeBakey-Satinsky Bulldog Clamps

- Curved
- 100mm Length jaws



CV-AS 4059 - 10

## Surgicals & Instruments

Quality is Reward of Hardwork

### BULLDOG CLAMPS

#### Gregory 'Soft' Carotid Bulldog Clamps

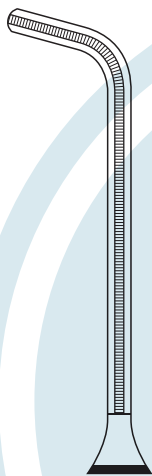

Overall Lengtht  
Jaw Length

110mm  
60mm

Code **MV-AS 4003 - 11**

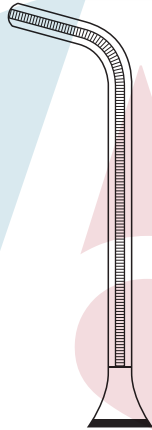

105mm  
55mm

Code **AS 4003 - 10**

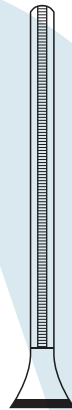

110mm  
44mm

Code **MV-AS 4003 - 11**

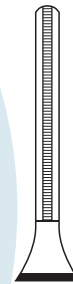

90mm  
27mm

Code **MV-AS 4003 - 90**

#### Modified Gregory 'Soft' Bulldog Clamps

- Curved
- Weight 12g

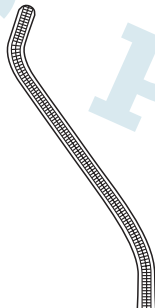

Overall Lengtht  
Jaw Length

11mm  
60mm

Code **CV-AS 4054 - 11**

Curved to Left



110mm  
60mm

Code **CV-AS 4055 - 11**

Curved to Right

## Surgicals & Instruments

Quality is Reward of Hardwork

### DeBakey Bulldog Clamps

### BULLDOG CLAMPS

- Straight



Overall Length  
Jaw Length

Code

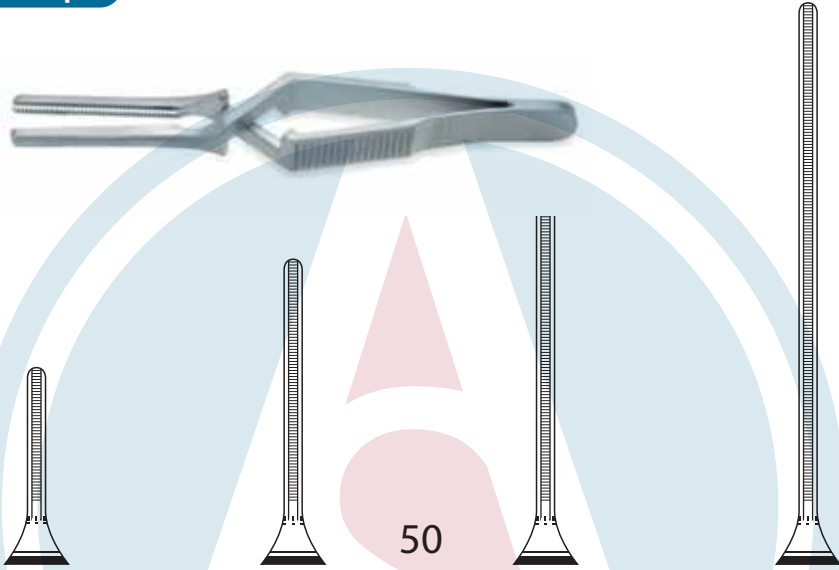

80mm  
20mm

CV-AS 4003 - 08

90mm  
30mm

CV-AS 4003 - 09

50

105mm  
45mm

CV-AS 4003 - 10

125mm  
68mm

CV-AS 4003 - 12

### DeBakey Bulldog Clamps

- Curved



Overall Length  
Jaw Length

Code

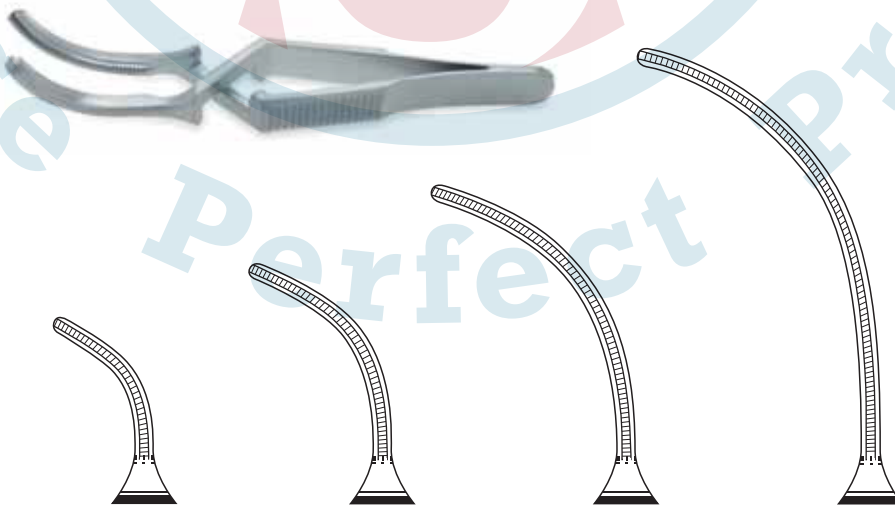

75mm  
20mm

CV-AS 4004 - 08

85mm  
30mm

CV-AS 4004 - 09

95mm  
45mm

CV-AS 4004 - 10

115mm  
68mm

CV-AS 4004 - 12



## Surgicals & Instruments

Quality is Reward of Hardwork

### BULLDOG CLAMPS

#### Titanium DeBakey Bulldog Clamps

- Straight

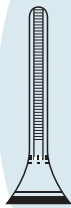

80mm  
20mm

CV-AS 4003-08T

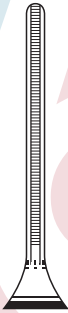

90mm  
30mm

CV-AS 4003-09T

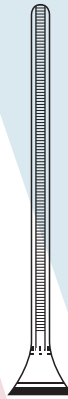

105mm  
45mm

CV-AS 4003-10T

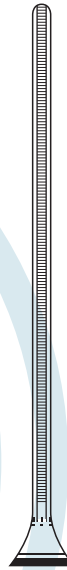

125mm  
68mm

CV-AS 4003 -12T

Overall Length  
Jaw Length

Code

#### Titanium DeBakey Bulldog Clamps

- Curved

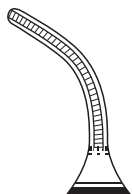

75mm  
20mm

CV-AS 4004-08T

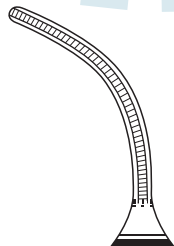

85mm  
30mm

CV-AS 4004-09T

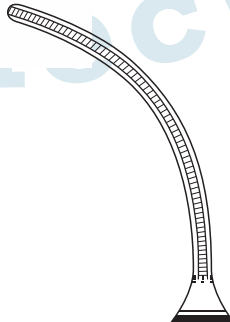

95mm  
45mm

CV-AS 4004-10T

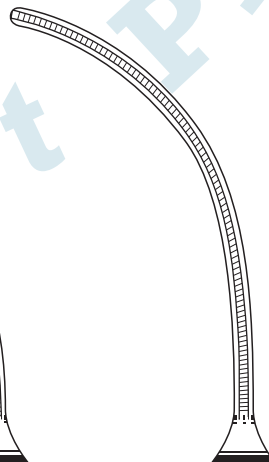

115mm  
68mm

CV-AS 4004-12T

Overall Length  
Jaw Length

Code



## Surgicals & Instruments

Quality is Reward of Hardwork

### BAYONET MICRO INSTRUMENTS FOR DURAL REPAIRS

#### Yasargil Bayonet Micro Needle Holder

- Flat Handled
- Delicate 1 mm jaws



With lock	Straight	Curved	Without lock	Straight	Curved
23cm/9"	MV-AS 1012-23	MV-AS 1013-23	23cm/9"	MV-AS 1112-23	MV-AS 1113-23

#### Bayonet Micro Needle Holder

- Round Handled
- Delicate 1 mm jaws



With lock	Straight	Curved	Without lock	Straight	Curved
21cm/8¼"	MV-AS 1010-21	MV-AS 1011-21	21cm/8¼"	MV-AS 1110-21	MV-AS 1111-21
23cm/9"	MV-AS 1010-23	MV-AS 1011-23	23cm/9"	MV-AS 1110-23	MV-AS 1111-23

#### Yasargil Bayonet Micro Forceps

- Flat Handled
- Blunt 1mm Tips



22.5cm/8¼"	MV-AS 2301-22
24cm/9¼"	MV-AS 2301-24

#### Yasargil Bayonet Micro Scissors

- Flat Handled
- 22.5cm/8¼" length



Standard Blade



Straight  
PS-AS 3005-22

Vannas Blade



Straight  
PS-AS 3005-22



Curved  
PS-AS 3006-22



Curved  
PS-AS 3006-22



## Surgicals & Instruments

Quality is Reward of Hardwork

### Slim Nose Wire Twisters

- 19cm/7½"

AS-PS7645-19



### Orthopaedic Locking Grips

- Hardened Jaws



Length

200-511-180	18cm/7"	Small
200-511-200	20cm/8"	Medium
200-511-240	24cm/9½"	Large

### Combined Wire Cutter & Pliers

- 18cm/7"
- Suitable for wire up to 1.6mm

200-512-185





## Surgicals & Instruments

Quality is Reward of Hardwork

### MISC INSTRUMENTS

#### Bolt Cutters with dismantable arms

- Max.cap 6.3mmpins
- 57cm length

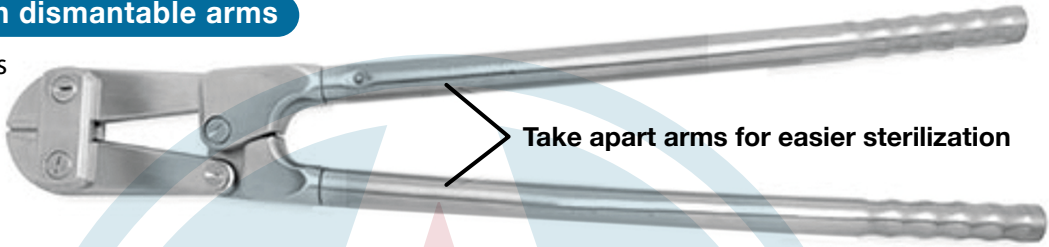

Take apart arms for easier sterilization

200-500-585

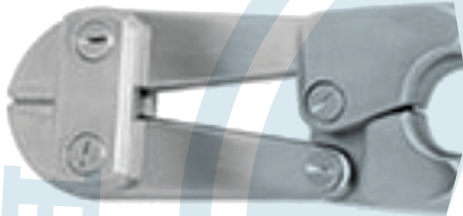

- Must be used in conjunction with a Rod Holdet
- Ordering Code 200-675-200

#### Muller-Claus Wire Cutters

- Tungsten Carbide Jaws
- Double Action

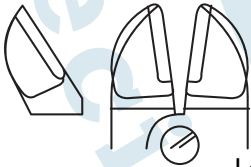

Length

8-810 E18

18cm/8"

- Sui

8-800 E22

22cm/8½"

- Suitable for wires up to 3mm diameter



#### Combined Wire Cutter & Pliers

- 18cm/7"
- Suitable for wire up to 1.6mm



Length

200-514-220

22cm/8½"

Small

200-514-220

25cm/9½"

Medium

200-514-220

30cm/11½"

Large

- A very useful instrument for orthopaedic surgery allowing the surgeon to securely clamp on to wires and implant.

## Surgicals & Instruments

Quality is Reward of Hardwork

### Measuring Caliper

- 25cm/10"

PS-AS 7334-20

### MISC INSTRUMENTS

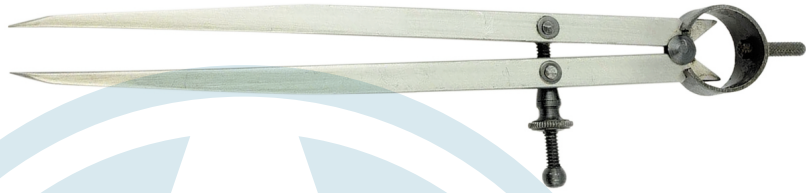

### Castroviejo Caliper

- 7cm/2 1/4"
- Measuring range 3mm to 25mm

PS-AS 7334-10

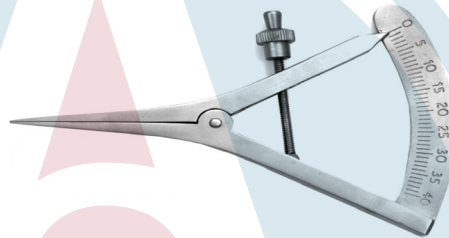

### Vernier Caliper

- 22.5cm/9"
- Measuring range 15cm

PS-AS 7338-00

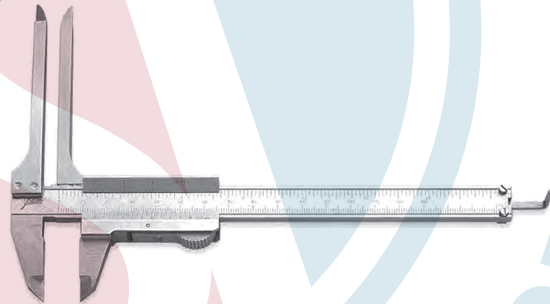

### Depth Gauge

- Measuring depth up to 50mm

PS-AS 7350-00



### Depth Gauge

- Measuring depth up to 70mm

PS-AS 7370-00



### Direct Reading Depth Gauge

- 23cm Length
- Measuring range 0.5 to 70mm

PS-AS 7333-00







## Surgicals & Instruments

Quality is Reward of Hardwork

### Frazier Suction Tube

### MISC INSTRUMENTS

- 17cm/6¼"

PS-AS 9041-17	6FG	2.0MM
PS-AS 9042-17	7FG	2.3MM
PS-AS 9043-17	8FG	2.7MM
PS-AS 9044-17	9FG	3.0MM
PS-AS 9045-17	10FG	3.3MM
PS-AS 9046-17	11FG	3.7MM
PS-AS 9047-17	12FG	4.0MM



### Frazier Suction Tube

- 23cm/9"

PS-AS 9041-23	6FG	2.0MM
PS-AS 9042-23	7FG	2.3MM
PS-AS 9043-23	8FG	2.7MM
PS-AS 9044-23	9FG	3.0MM
PS-AS 9045-23	10FG	3.3MM
PS-AS 9046-23	11FG	3.7MM
PS-AS 9047-23	12FG	4.0MM



### Bayonet Dissecting Forceps

19cm/7½" Tip Size

PS-AS 9701-19	1mm
PS-AS 9702-19	2mm

21cm/8½" Tip Size

PS-AS 9701-21	1mm
PS-AS 9702-21	2mm





## Surgicals & Instruments

Quality is Reward of Hardwork

### DeBakey Peripheral Clamp

### VASCULAR CLAMPS

- 17cm/6¼"

- Illustrated



Straight Shanks\*

19.5cm/7¼"

CV-AS 6042-19



Straight Shanks

22cm/8¼"

CV-AS 6042-22

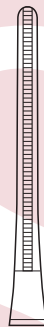

Angle Shanks

19.5cm/7¼"

CV-AS 6044-19



Angle Shanks

22cm/8¼"

CV-AS 6044-19



### DeBakey Peripheral Clamp

- Curved Shanks
- Angled 45°

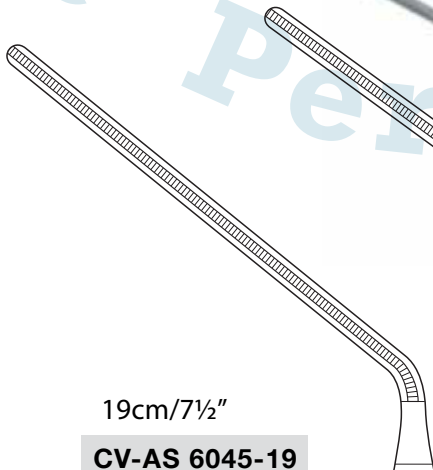
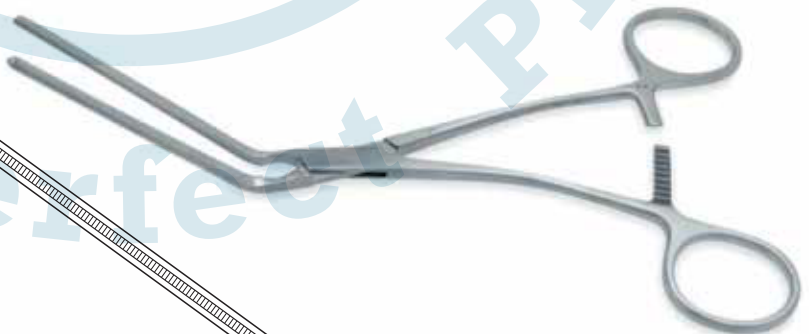

19cm/7½"

CV-AS 6045-19

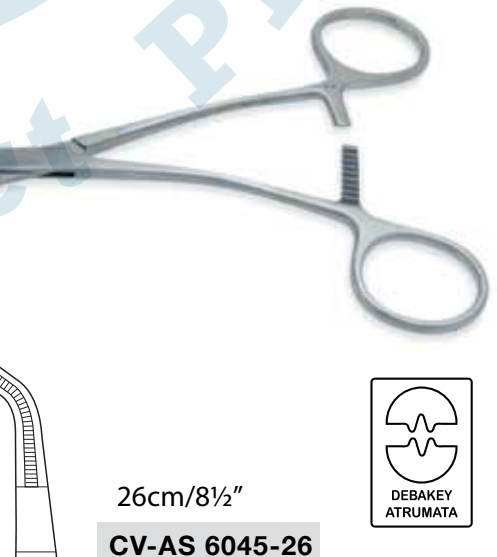

26cm/8½"

CV-AS 6045-26





## Surgicals & Instruments

Quality is Reward of Hardwork

### VASCULAR CLAMPS

#### DeBakey Multi-Purpose Clamp

- 17cm/6¼"

- Illustrated

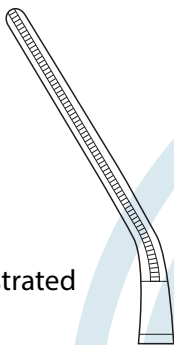

30° Angled Jaws  
16cm/6¼"

**CV-AS 6055-16**

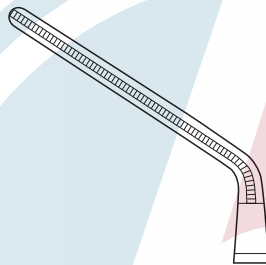

60° Angled Jaws  
15.5cm/6"

**CV-AS 6055-15**

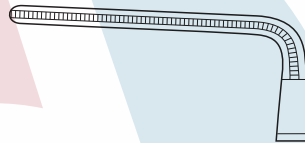

90° Angled Jaws  
14.5cm/6¼"

**CV-AS 6055-14**



#### DeBakey Multi-Purpose Clamp

- Curved Shanks
- Angled 60°

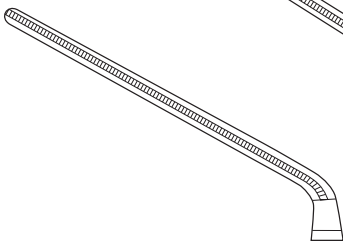

**CV-AS 6052-20**

20cm/8"

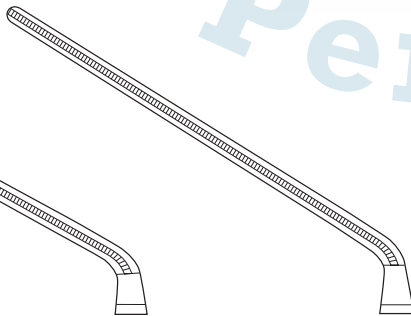

**CV-AS 6052-24**

24cm/9¼"

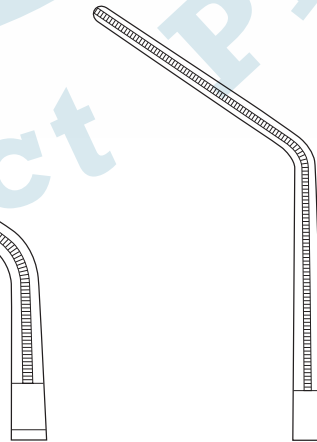

**CV-AS 6052-30**

30cm/12"



**CV-AS 6052-25**

25cm/10"



- Illustrated



## Surgicals & Instruments

Quality is Reward of Hardwork

### DeBakey Multi-Purpose Clamp

### VASCULAR CLAMPS

- Angled 90°

- Illustrated

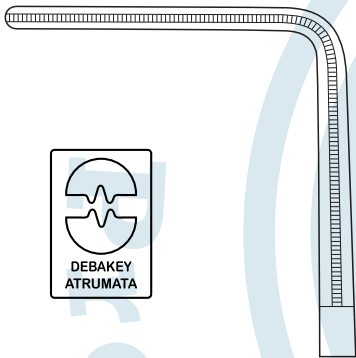

CV-AS 6054-23

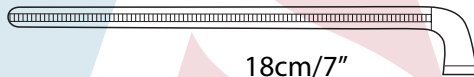

18cm/7"

CV-AS 6054-18

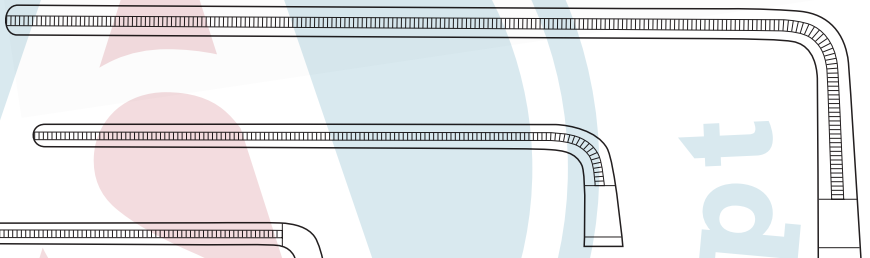

21.5cm/8½"

CV-AS 6054-21

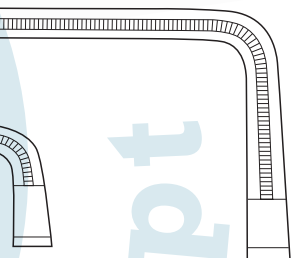

27.5cm/10¼"

CV-AS 6054-27

### DeBakey-Beck Paediatric Aortic Forceps

- Straight Shanks

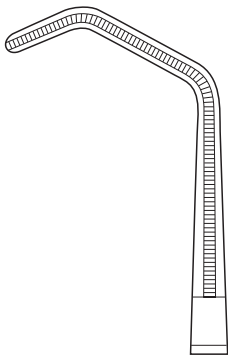
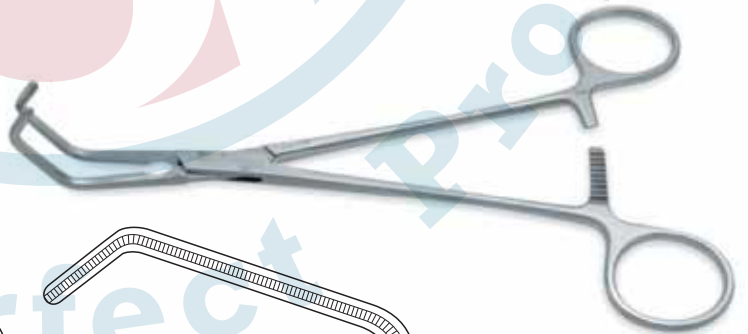

CV-AS 6057-16

16.5cm/6½"  
Small

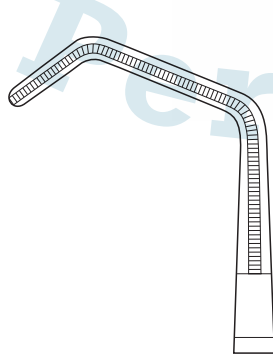

CV-AS 6057-19

19.5cm/7¼"  
Medium

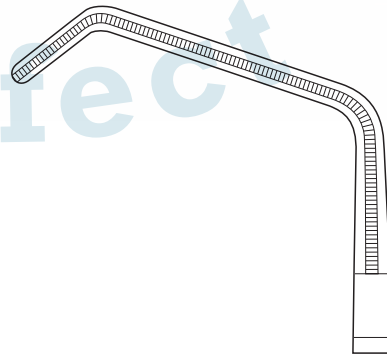

CV-AS 6057-20

20.5cm/8"  
Large





## Surgicals & Instruments

Quality is Reward of Hardwork

### VASCULAR CLAMPS

#### DeBakey Tangential Occlusion Clamp

- Curved Shanks

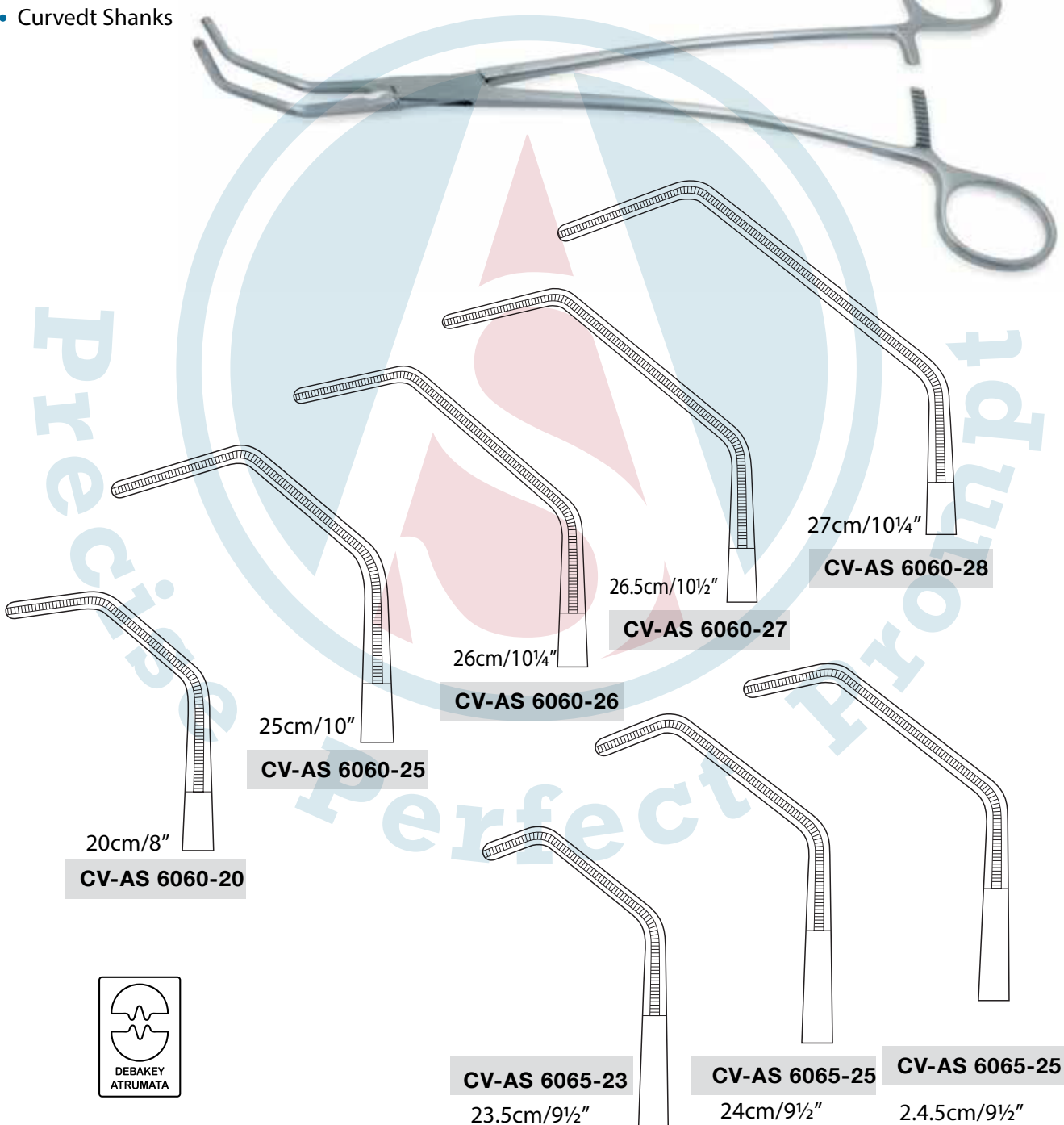
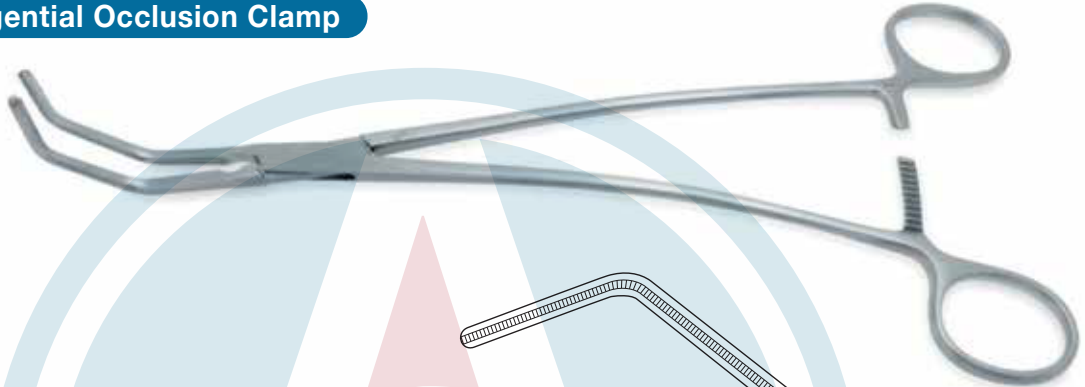

20cm/8"  
**CV-AS 6060-20**

25cm/10"  
**CV-AS 6060-25**

26cm/10¼"  
**CV-AS 6060-26**

26.5cm/10½"  
**CV-AS 6060-27**

27cm/10¾"  
**CV-AS 6060-28**

**CV-AS 6065-23**  
23.5cm/9½"

**CV-AS 6065-25**  
24cm/9½"

**CV-AS 6065-25**  
24.5cm/9½"





## Surgicals & Instruments

Quality is Reward of Hardwork

### VASCULAR CLAMPS

#### DeBakey Anastomosis Clamp

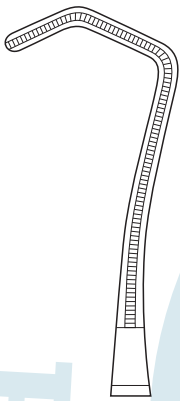

17cm/9½"

MV-AS 6068-17

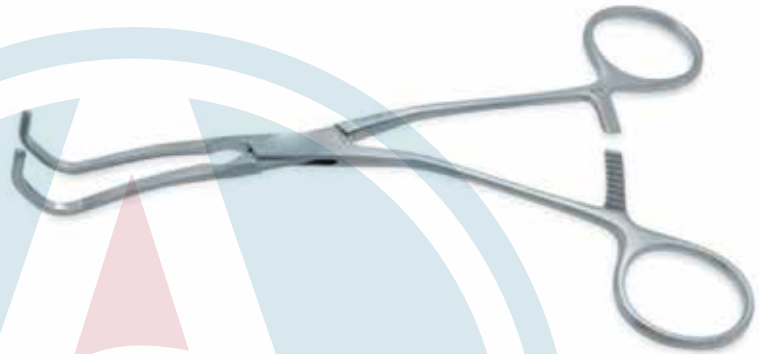

#### DeBakey-Derra Anastomosis Clamp

- 17cm/6½" Length

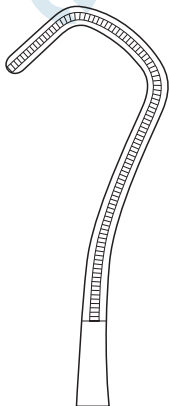

CV-AS 6070-17

Small

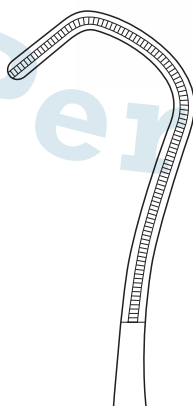

CV-AS 6071-17

Medium

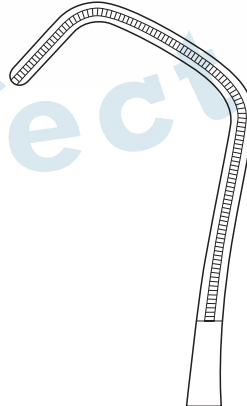

CV-AS 6072-17

Large

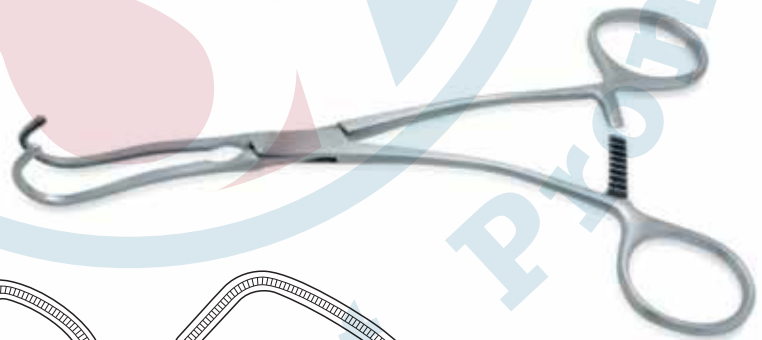



## Surgicals & Instruments

Quality is Reward of Hardwork

### VASCULAR CLAMPS

#### DeBakey-Semb Ligature Carrier

- 25cm/10" Length



CV-AS 610-AS 4-25

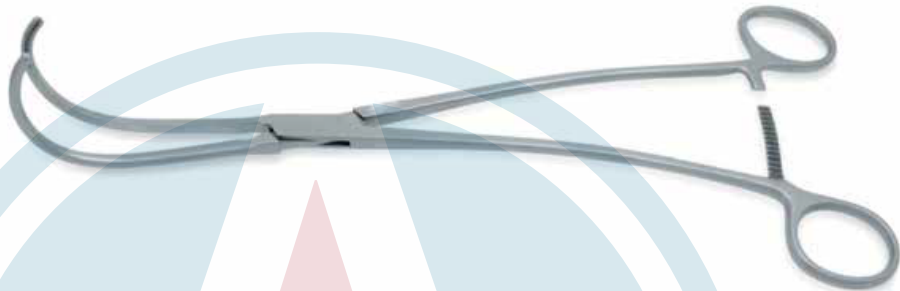

#### DeBakey Ligature Forceps

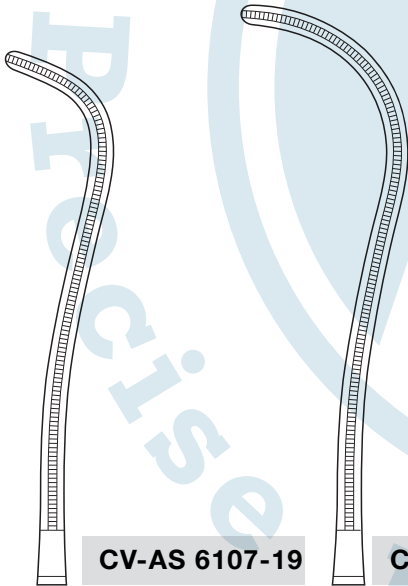

CV-AS 6107-19

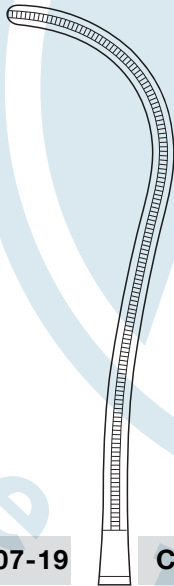

CV-AS 6108-19

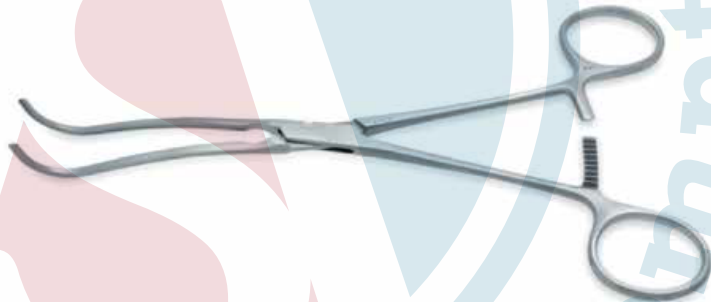

#### Semb Ligature Forceps

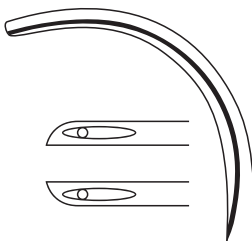

CV-AS 6110-23



CV-AS 6111-24





## Surgicals & Instruments

Quality is Reward of Hardwork

### Cooley-Derra Anastomosis Clamp

- 25cm/10" Length

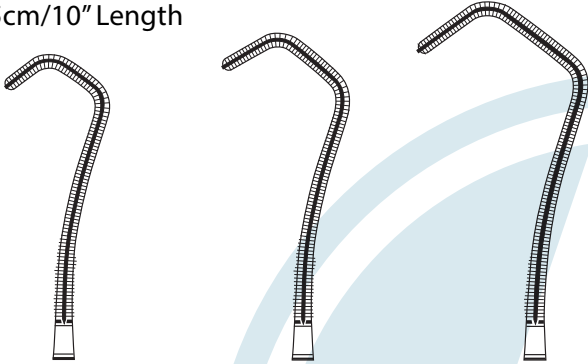

**CV-AS 6115-16**

Small  
16.5cm/6½"

**CV-AS 6116-17**

Medium  
17cm/6½"

**CV-AS 6117-17**

Large  
17.5cm/7"

### VASCULAR CLAMPS

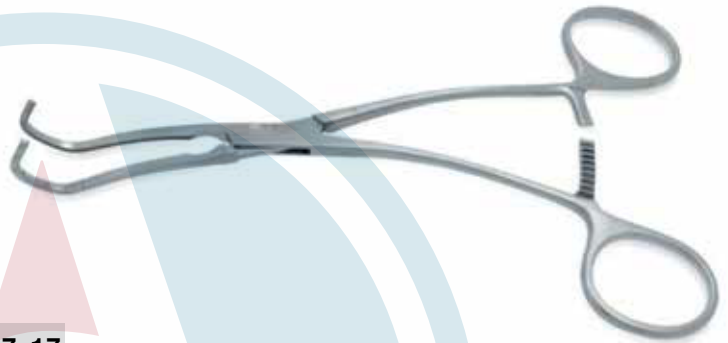

### DeBakey Vascular Clamp

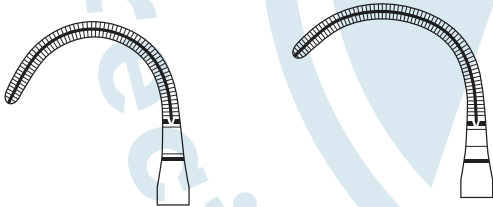

**CV-AS 6120-15**

15cm/6"

**CV-AS 6121-15**

15cm/6"



### Cooley Coarctation Clamp

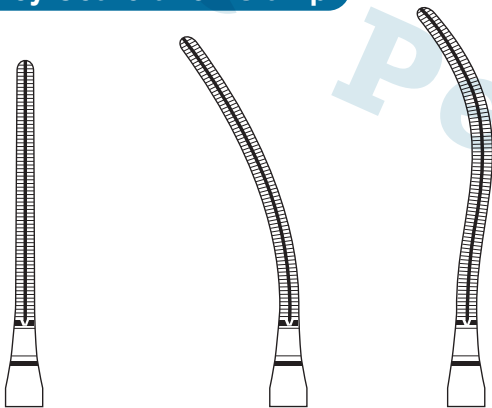

**CV-AS 6140-17**

17cm/6¾"

**CV-AS 6141-17**

17cm/6¾"

**CV-AS 6142-18**

18cm/7"







## Surgicals & Instruments

Quality is Reward of Hardwork

### Javid Carotid Clamp

- Small Size
- 15cm/6" Length

**CV-AS 6200-15**

For holding the shut tube during Carotid Surgery



### Javid Carotid Clamp

- Large Size
- 18cm/7" Length

**CV-AS 6200-18**

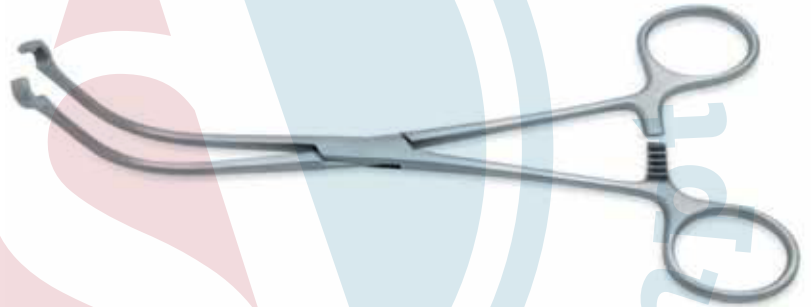

### Dardik Multi-Purpose Clamp

Jaw Angle      15cm/6" length      17cm/6¾" length

0°	<b>CV-AS 6125-00</b>	<b>CV-AS 6130-00</b>
15°	<b>CV-AS 6125-15</b>	<b>CV-AS 6130-15</b>
30°	<b>CV-AS 6125-30</b>	<b>CV-AS 6130-30</b>
45°	<b>CV-AS 6125-45</b>	<b>CV-AS 6130-45</b>
90°	<b>CV-AS 6125-90</b>	<b>CV-AS 6130-90</b>

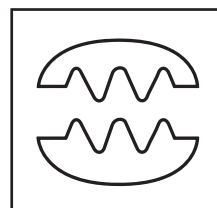
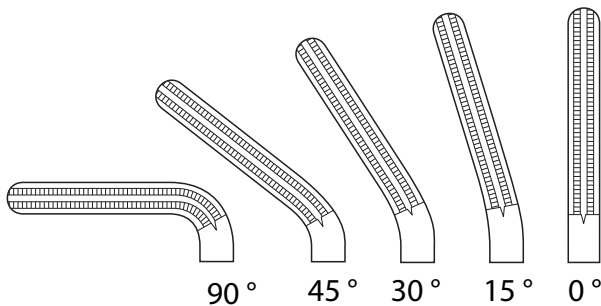
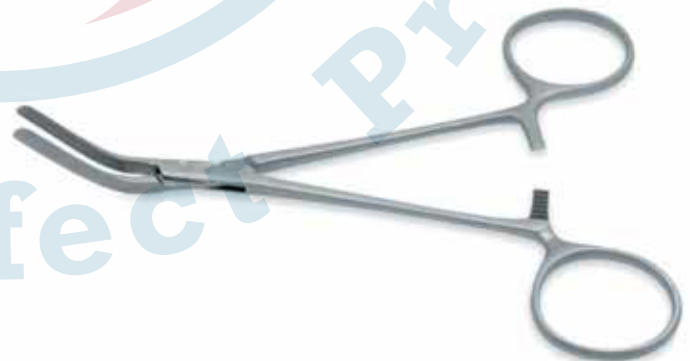



## Surgicals & Instruments

Quality is Reward of Hardwork

### Frazier Suction Tube

### SUCTION TUBES & CANNULA

- Angled 30°

Overall Length

Diameter ø	17cm/6½"	23cm/9"
2.0mm 6FG	CP-AS 9041-17	CP-AS 9041-17
2.3mm 7FG	CP-AS 9042-17	CP-AS 9042-17
2.7mm 8FG	CP-AS 9043-17	CP-AS 9043-17
3.0mm 9FG	CP-AS 9044-17	CP-AS 9044-17
3.3mm 10FG	CP-AS 9045-17	CP-AS 9045-17
3.7mm 11FG	CP-AS 9046-17	CP-AS 9046-17
4.0mm 12FG	CP-AS 9047-17	CP-AS 9047-17



### American Pattern Suction Tube

- 16.5cm/6½" Length

AS-CV7402-16



### Brompton Hospital Suction Tube

- 30cm/11¼" Length

CV-AS 7406-30 Adult size for 9.5mm/¼" tubing

CV-AS 7406-30 Child size for 9.5mm/¼" tubing



### Brompton Hospital Suction Tube

- Paediatric 4.8mm ø Tip size
- 23cm/9" Length
- For 6.5cm/¼" tubing

CV-AS 7403-23



### Southampton Western Hospital Suction Tube

- 22cm/8½" Length
- Paediatric 3.3mm ø
- For 6.5cm/¼" tubing

CV-AS 7401-22





## Surgicals & Instruments

Quality is Reward of Hardwork

### Tibbs Arterial Cannula

### SUCTION TUBES & CANNULA

- Long Pattern
- Luer lock

Set of 4	<b>CV-AS 7200-10</b>
Large Cone	<b>CV-AS 7200-20</b>
Small Cone	<b>CV-AS 7200-30</b>
Large Olive	<b>CV-AS 7200-40</b>
Small Olive	<b>CV-AS 7200-50</b>

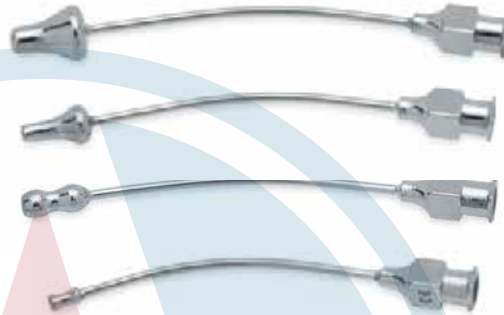

### Heparin Flushing needle

- Luer lock

2mm ø Tip	<b>CV-AS 7201-20</b>	2mm ø Tip	<b>CV-AS 7201-25</b>	2mm ø Tip	<b>CV-AS 7201-30</b>
-----------	----------------------	-----------	----------------------	-----------	----------------------



### Magill Suction Tube

- 21cm/8¼" Length

3mm ø Tip	<b>CV-AS 7401-20</b>	3.5mm ø Tip	<b>CV-AS 7402-21</b>	4.0mm ø Tip	<b>CV-AS 7403-21</b>
-----------	----------------------	-------------	----------------------	-------------	----------------------



### Yankauer Suction Tube

- 30.5cm/12" Length

**AS-CV7409-30**

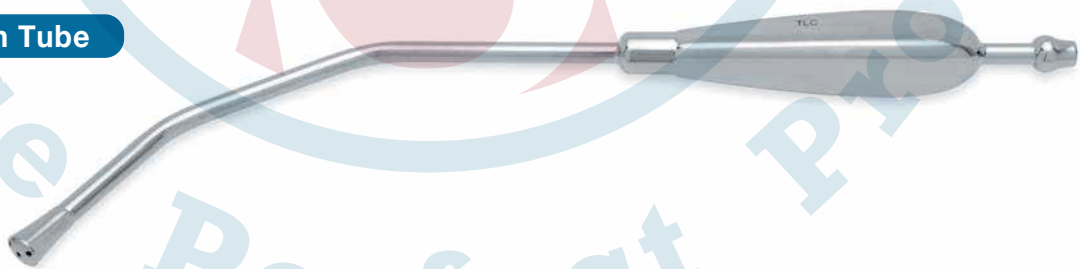

### Yankauer Suction Tube

- 24cm/9¼" Length
- 23cm/9½" Length
- 10mm ø

<b>CV-AS 7405-24</b> Straight mount *illustrated	<b>CV-AS 7406-24</b> Curved mount
--	-----------------------------------



### Paediatric Pooler Suction Tube

- 15cm/6" Length
- 6mm ø



## Surgicals & Instruments

Quality is Reward of Hardwork

### PERFUSION CANNULA

#### Ross Atrial Basket



Length	Tubing size $\varnothing$	code
29mm	1/2" /12.7mm	CV-AS 7205-15
29mm	1/2" /9.5mm	CV-AS 7205-20
19mm	1/2" /9.5mm	CV-AS 7205-25
16mm	1/2" /6.3mm	CV-AS 7205-30

#### Ross Sump Sucker (screw apart)



	diameter	Tubing size $\varnothing$	code
Adult	29mm	1/2" /12.7mm	CV-AS 7205-15
Child	29mm	1/2" /9.5mm	CV-AS 7205-20
Infant	19mm	1/2" /9.5mm	CV-AS 7205-25

#### Ross Sump Sucker (screw apart)



	diameter	Tubing size $\varnothing$	code
Adult	7.5mm	3/4" /5.0mm	CV-AS 7206-75
Child	6.5mm	3/4" /5.0mm	CV-AS 7207-65
Infant	5.0mm	1/2" /3.5mm	CV-AS 7207-50

#### Baylor Sump Sucker (screw apart)



outside diameter	45°angled	90°angled
4.0mm	CV-AS 7208-40	CV-AS 7209-40
5.0mm	CV-AS 7208-50	CV-AS 7209-50
6.0mm	CV-AS 7208-60	CV-AS 7209-60

#### Baylor Sump Sucker (screw apart)

Rolled edge to bevel



bore $\varnothing$	code	bore $\varnothing$	code
1.5mm	CV-AS 7210-15	4.5mm	CV-AS 7210-45
2.0mm	CV-AS 7210-20	5.0mm	CV-AS 7210-50
2.5mm	CV-AS 7210-25	5.5mm	CV-AS 7210-55
3.0mm	CV-AS 7210-30	6.0mm	CV-AS 7210-60
3.5mm	CV-AS 7210-35	6.5mm	CV-AS 7210-65
4.0mm	CV-AS 7210-40	7.0mm	CV-AS 7210-70

#### Iliac Cannula

- Angled



bore $\varnothing$	code	bore $\varnothing$	code
2.5mm	CV-AS 7211-15	4.5mm	CV-AS 7211-45
3.0mm	CV-AS 7211-20	5.0mm	CV-AS 7211-50
3.5mm	CV-AS 7211-25	5.5mm	CV-AS 7211-55
4.0mm	CV-AS 7211-30	6.0mm	CV-AS 7211-60

#### JS Venous Cannula

- Angled
- 80° angled
- Long tubing end



bore $\varnothing$	code	bore $\varnothing$	code
3mm	CV-AS 7212-30	6mm	CV-AS 7212-60
4mm	CV-AS 7212-40	7mm	CV-AS 7212-70
5mm	CV-AS 7212-50	8mm	CV-AS 7212-80

## Surgicals & Instruments

Quality is Reward of Hardwork

### VESSEL DILATORS & PROBES

#### Ross Coronary Artery Probe

- Same thickness along length of shaft



diameterø	10cm length	15cm length
0.5mm	CV-AS 7301-05	CV-AS 7302-05
1.0mm	CV-AS 7301-05	CV-AS 7302-10
1.5mm	CV-AS 7301-05	CV-AS 7302-15
2.0mm	CV-AS 7301-05	CV-AS 7302-20
2.5mm	CV-AS 7301-05	CV-AS 7302-25
3.0mm	CV-AS 7301-05	CV-AS 7302-30

#### DeBakey Vessel Dilator

- 190mm length
- Malleable shaft



diameterø	diameterø
0.5mm	CV-AS 7303-05
1.0mm	CV-AS 7303-05
1.5mm	CV-AS 7303-05
2.0mm	CV-AS 7303-05
2.5mm	CV-AS 7303-05
3.0mm	CV-AS 7303-05
3.5mm	CV-AS 7302-35
4.0mm	CV-AS 7302-40
4.5mm	CV-AS 7302-45
5.0mm	CV-AS 7302-50
7.0mm	CV-AS 7302-75
9.0mm	CV-AS 7302-90

#### Garrett Vessel Dilator

- Malleable Shaft



diameterø	21cm length	diameterø	21cm length
1.0mm	CV-AS 7304-10	1.0mm	CV-AS 7305-10
1.5mm	CV-AS 7304-15	1.5mm	CV-AS 7305-15
2.0mm	CV-AS 7304-20	2.0mm	CV-AS 7305-20
2.5mm	CV-AS 7304-25	2.5mm	CV-AS 7305-25
3.0mm	CV-AS 7304-30	3.0mm	CV-AS 7305-30
3.5mm	CV-AS 7304-35	3.5mm	CV-AS 7305-35
4.0mm	CV-AS 7304-40	4.0mm	CV-AS 7305-40
4.5mm	CV-AS 7304-45	4.5mm	CV-AS 7305-45
5.0mm	CV-AS 7304-50	5.0mm	CV-AS 7305-50



## Surgicals & Instruments

Quality is Reward of Hardwork

### STERILISATION CONTAINERS

#### SINGLE TRY CONTAINERS

Internal Dimension			Code
A	B	C	
200	140	50mm	E-AS 4026/1
280	195	50mm	E-AS 4026/4
265	255	50mm	E-AS 4026/5
380	260	50mm	E-AS 4026/7



E-AS 4026/5

Standard Container illustrated

One of our popular cases for Micro Instruments

#### DOUBLE TRY CONTAINERS

Internal Dimension			Code
A	B	C	
280	195	65mm	E-AS 4026/4 D
265	255	65mm	E-AS 4026/5 D
380	260	65mm	E-AS 4026/7 D

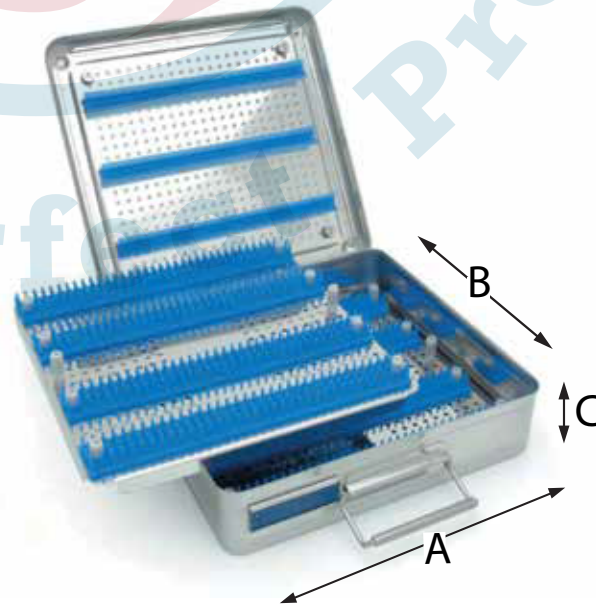

E-AS 4026/5 D

Double Tray Container illustrated

Two take-out perforated plates



## Surgicals & Instruments

Quality is Reward of Hardwork

### MISCELLANEOUS

#### Rummel Cardiac Stilette

- Sutue Hook
- 32.5cm Length



CV-AS 7008-32

#### Diamond Knife

- Titanium Handle with retractable blade
- 1mm x 6mm blade
- for neuro or cardiac surgery

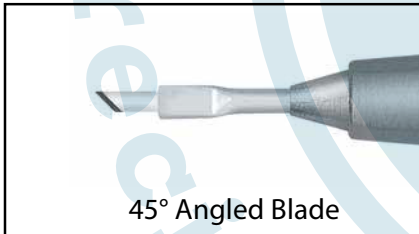

45° Angled Blade

CV-AS 7001-00

#### Stainless Steel Measuring Ruler

Code

Length

CA-AS 5005-15

15cm/6"

CA-AS 5005-30

30cm/12"





# Alliance

## Surgicals & Instruments

Quality is Reward of Hardwork

### Thompson Retractor System

CV-AS 7009-30

### ATTACHMENTS







# Alliance

## Surgicals & Instruments

Quality is Reward of Hardwork

### ATTACHMENTS

#### Bookwalter Retractor

CV-AS 7009-31

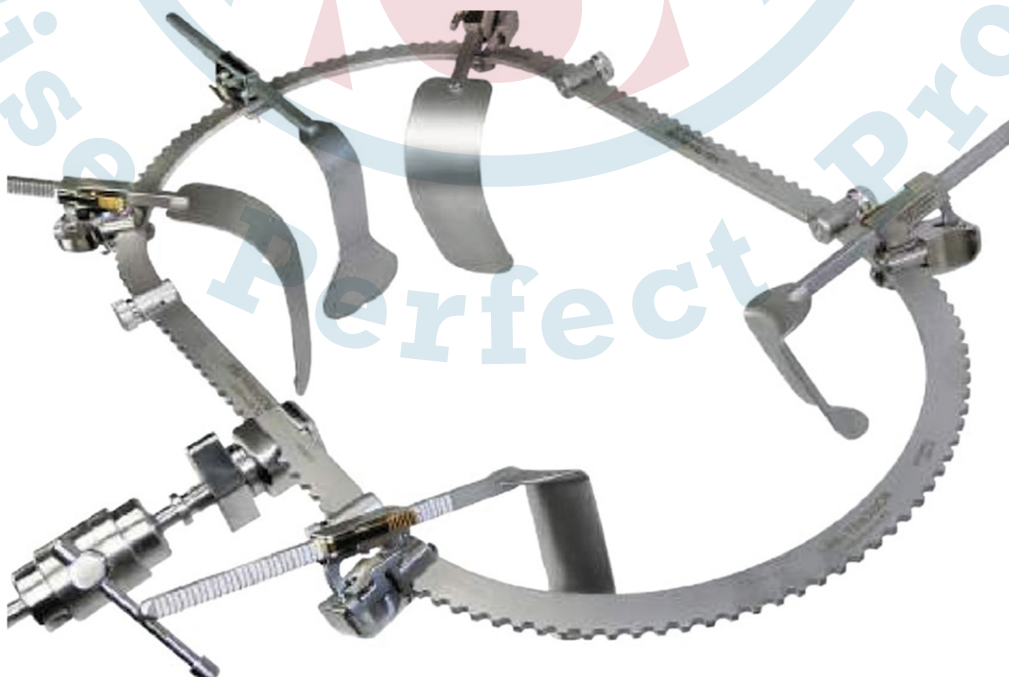
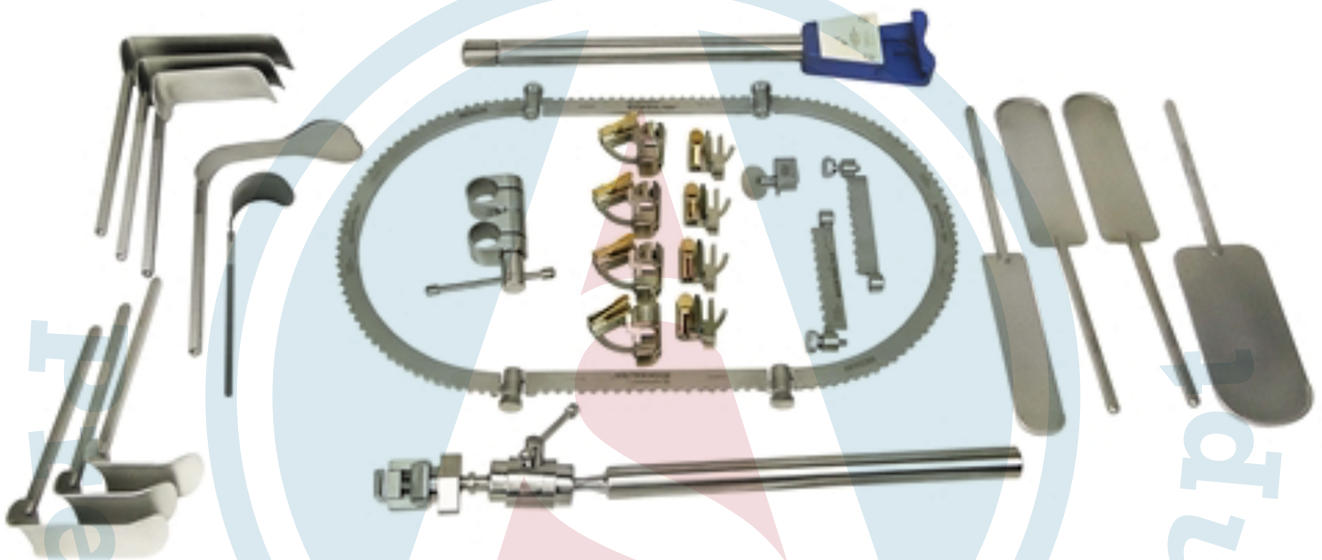



# Alliance

## Surgicals & Instruments

Quality is Reward of Hardwork

### ATTACHMENTS

#### Nathanson Liver Retractor

CV-AS 7009-32

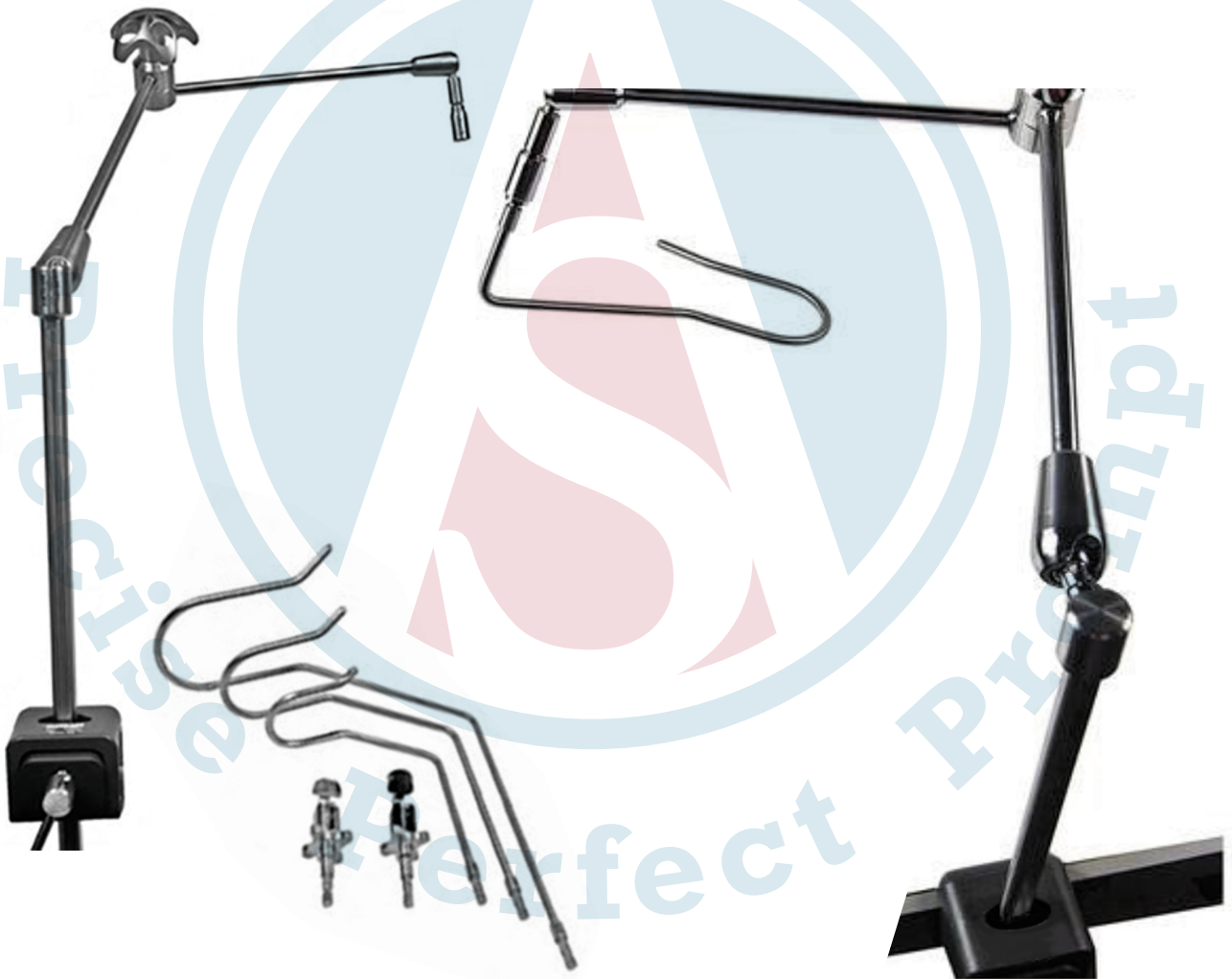



# Alliance

## Surgicals & Instruments

*Quality is Reward of Hardwork*

### WHO WE ARE

For the last 18 years, Alliance Surgical & Instruments customers have benefited from our outstanding industry knowledge and our ability to consistently provide high-quality specialized surgical instruments. Our Instrument Experts bring years of industrial experience to every customer interaction and fort constantly strive to meet our primary goal of -100% customer satisfaction.

Known for providing unsurpassed overall value, the instruments we sell are backed by a surgeon satisfaction guarantee. We will only provide you with a variety of quality instruments that will match your required specifications and deliver an equal- or superior-quality instrument with substantially more value and 99% of our customers report - surgeon satisfaction.

Our extensive knowledge comes from 18 years of industrial experience. And we will only provide you with a quote on instruments that match your instrumental specifications and deliver an equal or superior quality instrument with substantially more value.

*Quality is Reward of HARDWORK*



ANNANAD P.O, CHALAKUDY, THRISSUR, KERALA - 680309  
Email: [info@alliancesurgicals.com](mailto:info@alliancesurgicals.com), Website: [www.alliancesurgicals.com](http://www.alliancesurgicals.com)



# Alliance

## Surgicals & Instruments

*Quality is Reward of Hardwork*

**CDSO Reg No-Allian-Thris-KL/M/MD/009981**

Precise

Prompt

ANNANAD P.O, CHALAKUDY, THRISSUR, KERALA - 680309

Email: [info@alliancesurgicals.com](mailto:info@alliancesurgicals.com), Website: [www.alliancesurgicals.com](http://www.alliancesurgicals.com)